

Hotpoint®

COMPACT TUMBLE DRYERS USER HANDBOOK MODELS TS11 & TS12

KEY CONTACT NUMBERS SERVICE

UK: 0541 500 500

Republic of Ireland: 1850 302 200

GENUINE PARTS MAIL ORDER HOTLINE

UK: 0541 530 530

Republic of Ireland: (01) 842 6836

ACCESSORIES MAIL ORDER HOTLINE

0541 530 530

EXTENDED WARRANTY

To join: 0870 9 088 088

For further product information please contact:-



All Hotpoint Services are offered as an extra benefit and do not affect your statutory rights.
Applicable to UK only.

GENERAL DOMESTIC APPLIANCES LTD, PETERBOROUGH, PE2 9JB.

PRINTED BY SIMLEX FOUR ASHES, WOLVERHAMPTON.

August 1998 Part No. 930000109-02

Hotpoint®

Before you operate your Dryer

Using your new Tumble Dryer is easy. Nevertheless, for your own safety and to get the very best results it's important to get to know your Tumble Dryer by reading right through this Handbook **before** using your machine for the first time.

WARNING: IT IS IMPORTANT THAT YOU OBSERVE THE SAFETY GUIDELINES BELOW AND THE ADVICE GIVEN THROUGHOUT THIS HANDBOOK. MISUSE OF A TUMBLE DRYER MAY CREATE A FIRE HAZARD.

- | SAFETY GUIDELINES | Page |
|---|----------|
| 1. READ THIS HANDBOOK THOROUGHLY BEFORE USING THE MACHINE. | 4 |
| 2. COMPLY WITH THE ELECTRICAL REQUIREMENTS. | 4 |
| 3. SWITCH OFF AT SOCKET AND REMOVE PLUG AFTER USE – CHILDREN HAVE BEEN KNOWN TO CLIMB INTO TUMBLE DRYERS AND INJURE THEMSELVES. | 5 |
| 4. MAKE SURE THE EXHAUST AIR GRILLE AND VENT HOSE (OPTIONAL EXTRA MODEL 9305) ARE NOT BLOCKED OR OBSTRUCTED. | 5 |
| 5. MAKE SURE THAT THE MACHINE IS INSTALLED CORRECTLY AND HAS ADEQUATE VENTILATION. THE DRYER SHOULD NOT RECYCLE EXHAUST AIR. DO NOT USE THE MACHINE ON A CARPETED FLOOR WHERE THE PILE HEIGHT WOULD PREVENT AIR FROM CIRCULATING AROUND THE BASE. | 5 |
| 6. DO NOT OVERLOAD, OR LOAD ITEMS DRIPPING WET | 9 |
| 7. ONLY TUMBLE DRY ITEMS RECOMMENDED FOR TUMBLE DRYING. | 7, 8 & 9 |
| 8. DO NOT TUMBLE DRY ARTICLES WHICH ARE:
INFLAMMABLE OR CONTAIN INFLAMMABLE SUBSTANCES; ITEMS NOT RECOMMENDED FOR TUMBLE DRYING <input checked="" type="checkbox"/> ; OR ITEMS WHICH HAVE BEEN DRY CLEANED. | 11 |
| 9. CLEAN THE FLUFF FILTER AFTER EVERY LOAD. | 15-16 |
| 10. DO NOT OPERATE THE MACHINE WITHOUT THE FLUFF FILTER FITTED. | 16 |
| 11. HAVE YOUR MACHINE SERVICED ANNUALLY. | 17 |
| 12. ONLY FIT GENUINE HOTPOINT SPARE PARTS AND ACCESSORIES. | 17 |
| 13. DO NOT ATTEMPT TO STAND ON TOP OF YOUR DRYER. IT IS NOT DESIGNED FOR SUCH USE AND YOU COULD INJURE YOURSELF OR DAMAGE THE DRYER BY SUCH ABUSE. | |
| 14. WHEN SWITCHING ELECTRICITY ON OR OFF PLEASE ENSURE THAT YOUR HANDS ARE DRY. | |
| 15. DO NOT ALLOW CHILDREN TO TAMPER WITH THE CONTROLS OR PLAY WITH THE APPLIANCE. | |
| 16. NEVER SWITCH THE MACHINE OFF LEAVING A HOT LOAD IN THE DRUM. TERMINATE EVERY PROGRAMME WITH THE COOL CYCLE PROVIDED ON THE TIMER. | |

Hotpoint Service Cover

Satisfaction Guaranteed or Your Money Back

Hotpoint gives you a unique 'Satisfaction Guaranteed' promise – valid for ninety days after you have purchased your Hotpoint product. If there is a technical problem with your Hotpoint appliance, just call Hotpoint Service (see back page). If necessary we will arrange for an engineer to call. If the technical problem is not resolved under this Guarantee, Hotpoint will replace your appliance or, if you prefer, give you your money back. Your statutory rights are not affected, and the Guarantee is additional and subject to the terms of Hotpoint's Five Year Parts Guarantee.

Hotpoint's Free Five Year Guarantee

From the moment your appliance is delivered Hotpoint guarantees it for **FIVE YEARS**.

- In the Five Years all replacement parts are **FREE** provided that they are fitted by our own Service Engineer. During the first year our Engineer's time and labour is also free.
- Our guarantee covers loss of food in our refrigeration and freezer products up to £250 during the first year, subject to verification by one of our engineers.
- After the first year we will charge for our Engineer's time and labour. We do, however, operate a range of Service Plans (see opposite) which for an annual payment, enables you to cover any repair costs which may be necessary. All our service repairs are guaranteed for twelve months in respect of our labour and any parts fitted.
- The appliance must be used in the United Kingdom, and must not be tampered with or taken apart by anyone other than our own Service Engineers.
- You may, however, buy parts which can be safely fitted without specialist knowledge or equipment. The correct fitting of such parts, provided they are genuine Hotpoint spares, will not affect your Guarantee. Parts are available from our Hotpoint Spares Centres (see back page).
- Our guarantee does not cover the cost of any repair, or loss of food in refrigeration products, due to power failure, accidents or misuse. Nor does it cover the cost of any visits to advise you on the use of your appliance. Please read thoroughly the instruction book supplied with this appliance.
- If at any time during the Guarantee period we are unable to repair your appliance, we will refund any repair costs paid to us in the previous twelve months. We will also offer you a new appliance at a reduced charge instead of a repair.
- Our Guarantee is in addition to and does not affect your legal rights.
- Should you need independent advice on your consumer rights, help is available from your Consumer Advice Centre, Law Centre, Trading Standards Department and Citizens Advice Bureau.
- All Hotpoint servicing is carried out by our own Service Organisation located throughout the United Kingdom and Eire. We will be happy to deal with any problems which you may have.

Hotpoint's Extended Warranties

Whether you have just one or a number of Hotpoint appliances in your kitchen, Hotpoint has a range of Service Plans to give you complete peace of mind. They enable you to extend your one year labour guarantee so that you can have repairs completed **FREE** during the membership period.

Service Cover

We offer a number of payment methods: cheque, credit card or you can spread the cost and pay by direct debit (full details can be obtained on Free phone 0800 716356). This covers you for all repairs during the period of cover, which can be from 1 to 4 years. Service Cover also includes loss of food, up to the value of £250, in refrigeration appliances. There is also an option of Service Cover with Maintenance at an additional cost. This includes an annual Electrical and Safety check and replacement of any parts as necessary.

Kitchen Cover

An annual payment covers you for all repairs for all your Hotpoint appliances which are less than ten years old. It also covers the cost of loss of food up to £250 in our refrigeration and freezer products. There is also the option of Kitchen Cover with Maintenance at an additional cost. Any additional Hotpoint appliances purchased after you have joined Hotpoint Kitchen Cover will automatically be included during the annual period of cover without further charge.

Appliance Registration

To ensure that you have the opportunity to benefit from any of the above Service Schemes and other offers you should complete and return immediately the Appliance Registration Form/Questionnaire supplied with this appliance. Full details and costs of our Service Schemes, together with an application form, will be sent to you at the end of the first year of the guarantee.

Annual Safety/Maintenance Checks

Hotpoint strongly recommends that all its appliances are regularly checked for electrical and mechanical safety, whether or not they are covered by a Service Plan. Worn door gaskets or hoses may cause a leak on an appliance, which could become dangerous if neglected.

Proof of Purchase

For future reference please attach your purchase receipt to this booklet and keep it in a safe place.

Spares and Accessories

Spares and accessories can be ordered from your local Hotpoint Spares Centre (see back page), using the order form enclosed.

NOTE: Our Engineers will use every effort to avoid damage to floor coverings and adjacent units when carrying out repairs/service work, but in locations where the Engineer advises you that it will be impossible to move appliances without risk of damage, he will only proceed with your approval that no liability is accepted.

If something goes wrong...

First, don't panic!
There may be nothing wrong at all.
Look for your problem below, then check the things we suggest. More often than not, this will give you the answer to your problem, and you'll be able to carry on without having to telephone your Hotpoint Service Office.

If after this you still cannot get your machine to work, follow the advice given below.

Problem	Check these things first
<i>'It won't start'</i>	<ol style="list-style-type: none">1. Is the machine plugged in and switched on at the socket?2. Is the Timer Control set to the required time? (See page 13)3. Is the door securely closed?4. Has the fuse blown, either in the plug or in the main fuse box? (Try plugging in another appliance to check.) If the fuse has blown refer to the Electrical Requirements section page 4. Are the connections in the plug properly secured?
<i>'It is taking a long time to dry'</i>	<ol style="list-style-type: none">1. Have you forgotten to clean the filter? Check it. (See page 16.)2. Is the vent hose blocked? (See page 6.)3. Were the clothes 'dripping wet' when they were put in? (See pages 9 and 15)4. Have you overloaded the machine? (See page 9.)5. Has the correct heat setting been selected? (See page 13).
<i>Any other problem</i>	<i>Have you re-read the instruction book?</i>

If it still won't work...

Contact the Service Office

The model number of your machine (TS11 or TS12 for this machine), the serial number (found on the rear of the machine)

DISPOSAL OF YOUR PRODUCT

To minimise the risk of injury to children please dispose of your product carefully and safely. Remove all doors and lids (where fitted), Remove the mains cable (where fitted) by cutting off flush with the appliance and always ensure that no plug is left in a condition where it could be connected to the electricity supply.
To help the environment, Local Authority instructions should be followed for the disposal of your product.

This appliance conforms to the following EEC Directives:

Low Voltage Equipment
73/23/EEC
93/68/EEC

Electromagnetic Compatibility
89/336/EEC
92/31/EEC
93/68/EEC



Contents

	Page
Before you operate your new Dryer	2
Electrical Requirements	4
Get to know the main parts of your Dryer	5
Where to put your Dryer	5
What a tumble Dryer does	6
How to use your Dryer	7-8
Sorting your laundry	9
How to load the Dryer	10
Items not suitable for Tumble drying	11
Items requiring special attention	11-12
The Controls	13
Drying times	15
How to remove and clean the Fluff Filter	16
Caring for your machine	17
If something goes wrong	18
If it still won't work	18
Hotpoint Service Cover	19
Hotpoint Service Offices and Spares Centres	back page
Retention of this Instruction Book	

This Instruction Book must be kept handy for reference as it contains important details on the safe and proper use of the appliance.

If you sell or pass the appliance to someone else, or move house and leave it behind, make sure this Book is also provided so the new owner can become familiar with the appliance and safety warnings.

If the Book is lost or damaged a copy may be obtained from Hotpoint Ltd., Ceitia Road, Peterborough, PE2 9UB.

Electrical Requirements

Check that the voltage stamped on the rating plate of your machine (it's at the back) corresponds with your house electricity supply, which must be a.c. (alternating current). We recommend that this appliance is connected to the mains supply via a suitable switched socket in a readily accessible position. Your machine is already fitted with a plug incorporating a 13A fuse. If it does not fit your socket the plug should be cut off from the mains lead and an appropriate plug fitted. Throw away the cut off plug; do **not** insert it in a 13A socket elsewhere in the house as this could cause a shock hazard.

WARNING - THIS APPLIANCE MUST BE EARTHED.

Important – Fitting a Different Plug:

The wires in this mains lead are coloured in accordance with the following code:

- Green-and-yellow – Earth
- Blue – Neutral
- Brown – Live

If you fit your own plug, proceed as follows. The wire which is coloured green-and-yellow must be connected to the terminal in the plug which is marked with the letter 'E' or by the earth symbol (⏏), or coloured green, or green-and-yellow.

The wire which is coloured blue must be connected to the terminal which is marked with the letter 'N' or coloured black.

The wire which is coloured brown must be connected to the terminal which is marked with the letter 'L', or coloured red.

With alternative plugs a 15A fuse must be fitted either in the plug or adaptor or in the main fuse box. In the event of replacing a fuse in the plug supplied a 13A ASTA approved fuse to BS 1362 must be fitted. If the plug is the moulded on type the fuse cover must be refitted when changing the fuse. In the event of losing the fuse cover, the plug must **not** be used until a replacement fuse cover has been obtained and fitted. A new fuse cover can be obtained from your nearest Hotpoint Service Office or local Electricity Company. The colour of the correct replacement fuse cover is that of the coloured marks or insert in the base of the plug.

Note: We recommend the use of good quality plugs and wall sockets that can be switched off when the machine is not in use.

Mains Lead Replacement

Should the mains lead need replacing at any time please contact your nearest Hotpoint Service Office (see back page). A charge will be made for the replacement of the mains lead if you have damaged the lead or if you require a longer lead. This appliance conforms to EN55014 regarding suppression of radio and television interference.

Caring for your machine

Your Hotpoint Tumble Dryer needs very little attention. The following simple steps will keep it performing well.

When finished. Switch off electricity and remove plug, close the door.

After each load. Turn the drum by hand to check that small items like handkerchiefs do not get missed.

Important
Cleaning the Filter: It is essential that the lint is removed from the filter every time the Dryer is used. Failure to do this will result in poor drying performance and may lead to mechanical or electrical breakdown.

Occasionally wash the filter in tepid water and lightly use a nailbrush to remove any lint present after normal cleaning. Ensure filter is completely dry before re-using.

Every week. Wipe out the drum with a damp cloth.

As necessary. Clean exterior metal and plastic surfaces with a damp cloth or silicon polish only.

Do not use abrasive cleaners, scouring agents, acids, chlorine bleach or metal polish to clean any part of the machine. These could damage the machine.

Yearly. We recommend you take out a Hotpoint Service Cover Plan with annual safety/maintenance check which ensures the Dryer is professionally serviced every year. Details are given at the end of this book.

Hotpoint strongly recommends that all of its appliances are regularly checked for electrical and mechanical safety whether or not they are covered by a Hotpoint Service Cover Plan.

Lubrication: Your tumble dryer uses special bearing components. Lubrication by the user is not necessary and must not be attempted.

Spare Parts

Please remember your new appliance is a complex piece of equipment.

'DIY' repairs or unqualified and untrained service people may put you in danger, could damage the appliance and might mean you lose cover under Hotpoint's Parts Guarantee.

If you do experience a problem with the appliance don't take risks; call in Hotpoint's own Service Engineer. The address and telephone number of your nearest Hotpoint Service Office is in your local telephone directory.

Our spare parts are designed exclusively to fit only Hotpoint appliances. Do not use them for any other purpose as you may create a safety hazard.

How to remove and clean the Fluff Filter

A very important part of your Dryer is the filter located on the inside of the door. It is there to trap the particles of lint and fluff which are normally blown away when clothes are dried on the washing line.

If the filter is allowed to become blocked, the passage of warm air through the drum will be severely restricted. This means your clothes will take much longer than normal to dry and the cost of drying them increased.

The Vent Hose, if fitted (see pages 5 and 6), should be kept free of any possible accumulation of fluff, lint and condensate (water) by frequently shaking it out.

WARNING: DO NOT OPERATE THE DRYER WITHOUT CLEANING THE FILTER AFTER EACH DRYING CYCLE. FAILURE TO CLEAN THE FILTER MAY RESULT IN A POTENTIAL FIRE HAZARD. DO NOT ALLOW LINT TO COLLECT AROUND THE DRYER.

To remove the Filter
Simply place your fingers into the section provided at the top of the filter (see diagram below) and pull filter upwards.

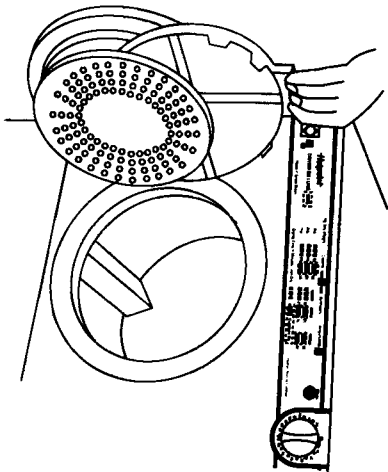

You can now remove the fluff that has collected on the mesh.

Don't be alarmed at the amount of fluff you may find on the filter; it's all part of the wearing, washing and drying process.

To replace the filter push firmly into position on the inside of the door.

WARNING: DO NOT OPERATE THE DRYER WITHOUT THE FILTER IN POSITION.

Get to know the main parts of your Dryer

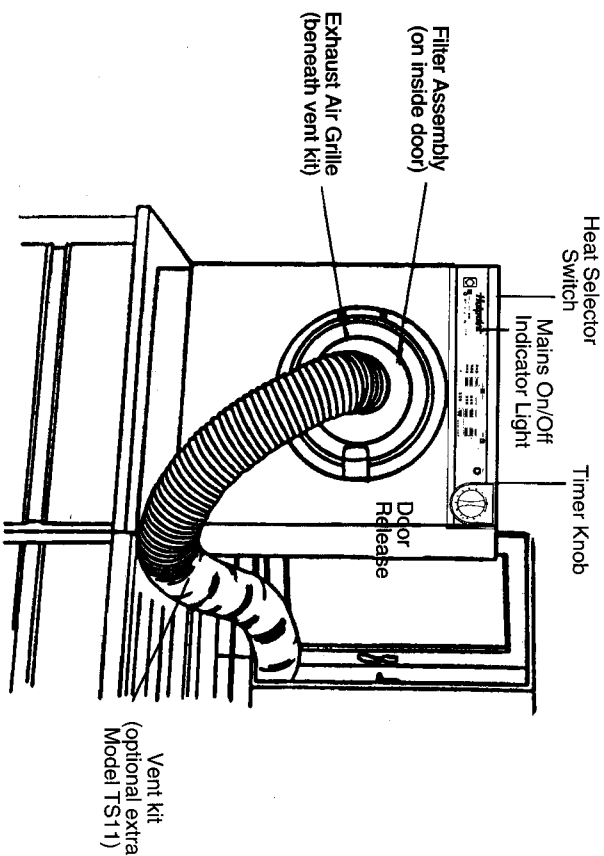

Where to put your Dryer

There is no internal packing to be removed before use, but do make sure the drum is quite empty. We advise that the drum is wiped out before its very first use to move any transit dust or other matter that may have entered the machine since it left our factory.

As air is intended to enter the base of the machine it should not be used on any carpeted surface where the pile height would prevent air flowing over the whole of the base, i.e. there should be a gap between the floor covering and the base of the cabinet.

Bathrooms and Shower Rooms

Regulations exist covering the use of electrical appliances in bathrooms and shower rooms.

It is important that no socket outlet is provided in those areas and Hoppoint recommends that its appliances are not positioned there.

If you have any questions about whether your proposed location complies with the

Regulations you should, for your own safety, seek guidance from a qualified electrician.

Your Tumble Dryer should **not** be located adjacent to a gas heater as flames from the burners could cause damage to your machine.

The Dryer dries your washing by drawing in air that is cool, clean and relatively dry, heating it to the required temperature, and blowing it through the clothes as they are gently tumbled. The moisture laden air is then blown out through the front of the machine. The amount of moisture varies with the size of the load, the types of fabric and how wet they were when put in.

The Dryer should be placed where air can freely circulate around it, preferably near a window which can be opened to reduce the possibility of condensation occurring while the Dryer is in use.

WARNING: ENSURE THAT THE EXHAUST AIR GRILLE (AT THE FRONT OF THE DRYER) AND VENT HOSE (OPTIONAL EXTRA MODEL TS11) ARE NOT BLOCKED OR OBSTRUCTED.

DO NOT ALLOW CLOTHES, TOWELS ETC. TO HANG DOWN THE FRONT OF THE DRYER INTO THE AIRSTREAM. THIS OBSTRUCTS THE AIR FLOW AND MAY DAMAGE YOUR DRYER. DO NOT OPERATE THE DRYER IN AN ENCLOSED ENVIRONMENT. ENSURE THAT THE DRYER IS ADEQUATELY VENTILATED, EG, BY OPENING A WINDOW, SO THAT IT DOES NOT RECYCLE EXHAUST AIR. MISUSE OF A TUMBLE DRYER MAY CREATE A FIRE HAZARD.

Vent Hose Kit for model TS11 (Part No. 9037)

This is an optional extra for model TS11 and its use is recommended where condensation is a particular problem.

The Kit consists of an adaptor and flexible hose which will take the moist air directly from the machine and out through an open window – thus avoiding a steamed-up kitchen. This can be used in conjunction with a Wall Vent Kit (Part No. 9028) or Window Vent Kit (Part No. 9029) for permanent installation.

Wall Hanging Kit (Part No. 179314)

This allows the Dryer to be mounted on a wall of suitable strength to take the weight. Alternatively it should be used when the Dryer is stood on top of a or work surface to secure the Dryer to the wall.

NOTE: The Vent Hose should not exceed 2.4m (8 feet) in length and should be kept free of any possible accumulation of fluff, lint and condensate (water), by frequently shaking it out.

Both the Vent Hose Kit and the Wall or Window Vent Kits are available from your retailer or nearest Hotpoint Spares Centre (see back page). Fitting instructions are supplied with all of these kits.

NOTE: It is essential that the storm cover, supplied with the Wall and Window Vent Kits, is always fitted.

What a Tumble Dryer Does

A tumble dryer gently tumbles the wet clothes in a current of warm air after they have been spun in a washing machine or spin dryer. Moisture is evaporated until the clothes are quite dry, much like a speeded up version of what takes place outdoors in a fresh breeze on a fine sunny day, in a clean fresh atmosphere.

But a good tumble dryer can do much more than this.

A good tumble dryer reduces unwanted creases as it dries, creases that may have been put in during spinning.

Drip-dry shirts dried in a dryer will be more crease-free than the same shirts given the same wash treatment and hung up to dry. Most materials will benefit from this effect, including cottons and linens, synthetic materials and mixtures of both. In some cases the need to iron will be eliminated, but it is important in order to achieve the maximum benefit that you should not overload the dryer. It is better to dry two small loads rather than one large load if crease removal is important. This will use slightly more electricity in drying than one large load, but will save on ironing. If you must iron then the maximum loadings given in the instructions will give the greatest efficiency in use of electricity.

Towels will be soft and bulky after drying in a tumble dryer, nappies will be smooth and fluffy, unlike the same articles which tend to be flattened and stiff when dried statically. Garments may be quickly aired after storage or warmed before use.

Many fabrics used in the manufacture of clothing and household textiles tend to undergo some change of size when laundered. This size change is due to relaxation of the fibres, which have been stretched during spinning and weaving, and which tend to return to their unstretched state when immersed in water. These fibres normally stretch again in use, and even hanging wet on a line stretches the material to some extent. Tumble drying does not put any tension on the fabric as line drying does, and the difference may therefore appear more noticeable when the garments are dry.

Drying Times

The time needed for drying clothes varies according to the following factors:

1. The amount of water which is left in the clothes after washing.
2. The weight of the load. A smaller load requires less time.
3. The type of fabric. More absorbent materials will take longer to dry.

4. Whether the clothes are to be dried fully, or left slightly damp for ironing. (If you wish to remove items while they are still damp you may do so at any time.)

As an approximate guide, the following table may assist you.

Material & Heat setting	Spun Speed	minutes to dry		
		1kg	2kg	3kg
Acrylics and acrylic mixtures Low Heat	reduced*	50-60	75-90	
Other synthetics Full Heat	reduced*	25-40	40-65	
All other materials	2,800 rpm Typical spin dryer	20-30	40-55	45-60
	800-1,100rpm washing machine 400-500rpm washing machine	25-35 30-45	45-60 65-80	65-80 85-100

All times indicated are markings on fascia around the timer knob and include 10 minutes cool down period. *Synthetics must be given reduced spin in accordance with garment manufacturers' recommendations. If a Vent Hose Kit is fitted drying times will be slightly longer.

After Tumbling

Switch off the electricity at the wall socket and remove plug.

To avoid unnecessary creasing, the garments should be removed from the dryer as soon as it stops.

All clothes lose lint as they wear. When clothes are hung on a washing line the lint is blown away by the wind. In a tumble dryer it is collected in the lint filter.

Be careful not to overdry
All fabrics contain a little natural moisture even when 'dry', and this natural moisture should not be lost if the clothes are to remain soft and fluffy. What's more, clothes that are subject to an overlong drying programme tend to wrinkle, and consequently need more ironing than usual, which gives you back the unnecessary extra work your machine was designed to remove.

It is essential that the lint is removed from the filter every time the dryer is used.

Failure to do this will result in poor drying performance and may lead to mechanical or electrical breakdown.

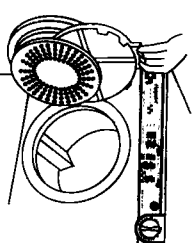

How to use your Dryer

Setting the Timer and starting the Dryer

Consult the Drying Guide (on the opposite page) for drying times (times are also shown on the fascia panel) and set the Timer by turning it clockwise to the required time. This will start the Dryer provided the door is closed and the Dryer plugged in.

You can check the dryness of the load as often as you wish - and, if you want to, remove some items before they are fully dry. (This is particularly useful for a mixed load where you want to iron some items but leave others to be fully dried.) If the door is opened, while the Dryer is in use, it will stop. The programme will resume from where it left off as soon as the door is reclosed without need to reset the Timer.

Should you wish, of course, the Timer can be reset at any stage of the programme.

WARNING: CHILDREN HAVE BEEN KNOWN TO CLIMB INTO TUMBLE DRYERS AND INJURE THEMSELVES. SWITCH OFF AT SOCKET AND REMOVE PLUG AFTER USE.

The 'Cool Tumble' phase

As the minutes tick by, the Timer will move towards the OFF (O) position. Approximately 10 minutes before the programme is completed, the heating elements will be switched off, and the programme enters the final 'Cool Tumble' phase. During this phase, the fabric is cooled. You should allow the Dryer to complete the 'Cool Tumble' phase before removing the clothes as this minimises creasing

and reduces the temperature of the load. Never switch off the Dryer leaving a hot load in the drum. You must always terminate a programme with a cool tumble phase.

1. Plug in, switch on electricity.

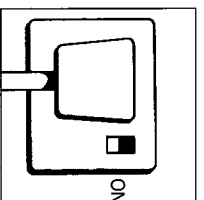
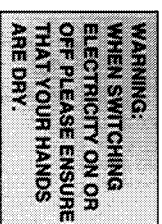

2. Sort your laundry (see page 9)

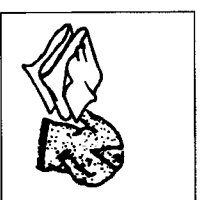

3. Open door.

Press Door Release handle outwards (see page 16) Clean and replace the Fluff Filter

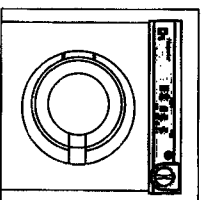

4. Load the Dryer and close the door (see page 10)

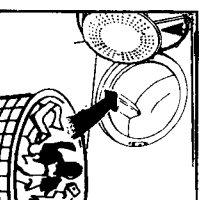

5. Select time required.

Turn timer knob clockwise to time required The Dryer will start (see page 13)

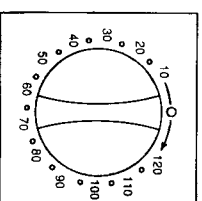

Model TS12

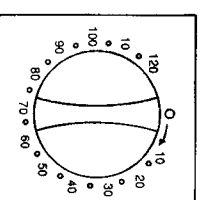

Model TS11

6. Select heat setting
Push in for full heat for cottons, linens & synthetics
Low setting – button out for acrylics and acrylic mixtures
High for cottons, synthetics and linens

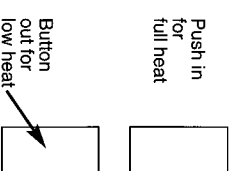

The Controls

Timer Control – Model TS11

7. When finished take out laundry.

8. Clean and replace Fluff Filter (see page 16)

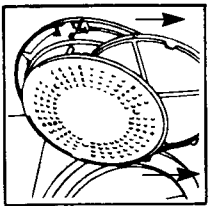

9. Switch off electricity and remove plug from socket

WARNING:
WHEN SWITCHING ELECTRICITY ON OR OFF PLEASE ENSURE THAT YOUR HANDS ARE DRY.

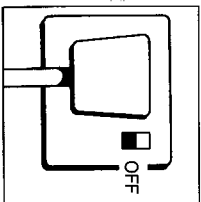

To operate the dryer, close the door and turn the timer control from the zero position in a **clockwise** direction slightly past the required drying time, then back to set the exact time.

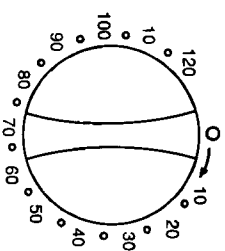

The timer can be set to any time up to 120 minutes and can be reset at any time as required to increase or reduce the time to dry. The timer is electrically driven and will therefore only advance when there is power supplied to the dryer and the dryer door is closed. The time indicated on the timer includes approximately 10 minutes of tumble with the heat off. Note that the dryer must never be turned off leaving the clothes in the drum without first completing the heat off cool-down period.

Timer Control – Model TS12

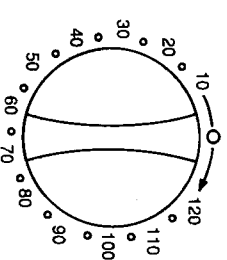

To operate the dryer, close the door and turn the timer control clockwise from 120 to the required drying time.

The timer can be set to any time up to 120 minutes and can be reset at any time as required to increase or reduce the time to dry, but in doing so the timer knob **must only be turned clockwise**. Turning the timer backwards will cause damage and it must therefore be turned forwards even to reach 'Off' position. The timer is electrically driven and will therefore only advance when there is power supplied to the dryer and the dryer door is closed. The time indicated on the timer includes approximately 10 minutes of tumble with the heat off. Note that the dryer should never be turned off leaving the clothes in the drum without first completing the heat off cool-down period.



Heat Control Switch

Low heat is obtained with the switch **OUT** and should be used to dry acrylics and acrylic mixtures (excluding wool mixtures). **Full heat** is obtained by pressing the switch **IN**, and should be used to dry other materials (excluding wool and wool mixtures). For instructions concerning wool see page 11.

Automatic Door Switch

The dryer will stop when the door is opened and will restart when the door is closed, allowing items to be added to or taken from the machine without the need to reset the controls.

Mains Light

This light indicates that there is power being supplied to the dryer when the wall socket is switched on.

Items requiring special attention (cont'd)

Blankets and Bedspreads

The drying requirements for blankets and bedspreads will, of course, vary tremendously according to size and weight. Your Dryer will do a splendid job, often restoring the soft, fluffy feel they had when new. Some, however are, simply too big. If you have difficulty getting them into the Dryer, the machine will have difficulty in drying them properly. During the drying period remove blankets and other large items, shake and reload. This will ensure more even drying. Blankets made from acrylic fibres (eg. Acrilan, Courtele, Orlon and Dralon) must be dried with special care. Overdrying should be avoided to ensure heat creasing does not occur.

It will help if you test them occasionally during the programme to see how they are coming along.

Permanently pleated or creased garments

Your Dryer will cope with such clothes very well, but you should always read the manufacturer's drying instructions attached to the garment before you begin.

Starched articles

Starched articles should be dried together in the same load, to avoid the distribution of starch to non-starched items.

You should use a slightly heavier starch solution than you would when drying the items on the washing line. Make sure that as much of the solution is removed from the load as possible before placing it in the Dryer.

Remove the items from the Dryer as soon as they reach ironing dampness. If they are over-dried, the starch will powder, leaving the fabric limp – which rather defeats the purpose of the exercise!

Fabric conditioner

To make sure all your tumble dried clothes come out really fresh and soft we recommend you use a fabric conditioner, such as *Comfort*, in the final rinse of your wash. A fabric conditioner restores bounce and softness to everything when it comes out of the Dryer. Using a fabric conditioner also helps eliminate static cling, which can be so irritating and uncomfortable, and thus makes ironing easier.

WARNING: ON NO ACCOUNT SHOULD LIQUID FABRIC CONDITIONER BE ADDED TO THE DRYER ITSELF.

Sorting your laundry

NOTE: The dryer is only intended for drying articles which have been well washed in water and detergent and have been well rinsed and spun.

1. It is best to sort everything into fabric groups.

It is very important to follow carefully each garment manufacturer's washing and drying instructions, as given on the Care Label attached to the garment.

The same grouping applies to washing machines, so you will probably already have done this when preparing your wash.

2. See that all zips are closed, hooks and eyes are fastened, and belts, strings etc. are tied loosely in bows. Once again, you will normally have already done this at the washing stage.

3. It is important to extract as much water as possible from each item before loading. This will save you time and money.

Do not overspin easy-care fabrics in your automatic washing machine or spin dryer. These fabrics dry quickly in a tumble dryer and many of them do not need ironing at all if they are dried in small loads.

Fabric conditioner will give even more softness to all fabrics and is invaluable for controlling the static electricity which causes easy-care fabrics to cling and attract dirt.

WARNING – CLOTHES SHOULD NEVER BE LOADED DRIPPING WET.

4. Make sure, by referring to the section on page 11, that items to be dried are suitable for tumble drying, or are not of the type requiring 'special attention' (see pages 11 & 12).

Articles that contain safety pins, hair grips, metal fastenings or stiffening (eg. bra wires) that may become detached should not be placed in laundry appliances. If they tumble free they could they could interfere with mechanical or electrical parts of your washer or dryer.

Maximum Load Size

Maximum loads are:

Cottons 3 kg (6½ lb.)

Synthetics and mixtures

1kg (2¼lb.) for minimum creasing

2kg (4½lb.) if creasing

unimportant

Synthetic fibres require more space to tumble dry without creasing therefore the maximum load is reduced compared to that of cottons.

Making up Loads

Clothes should be sorted into loads of similar fabrics before drying. Cotton which needs ironing can be dried to a suitable dampness. Towels and other cotton items which do not need ironing can be fully dried and these will be ready to wear or store as soon as they are taken from the dryer.

Heavy fabrics should be dried separately from lightweight fabrics.

Loose belts, apron strings etc. should be tied and zip fasteners fully closed before being placed in the dryer. Garments like jeans should be turned inside out to avoid damage to the drum by metal studs.

If you group small cotton or terry towelling items with a synthetic fabric load they could be damp at the end of the drying cycle. If this happens simply give them an additional short period of drying to finish them off.

WARNING – DO NOT OVERLOAD AS THIS COULD RESULT IN POORER DRYING PERFORMANCE AND A POSSIBLE FIRE HAZARD.

How to load the Dryer

1. Open the loading door by pulling the door handle forwards.
2. **Before loading the Dryer, make sure the fluff filter is in position and clean (see page 16).**
3. If your Dryer is brand new, wipe out the inside of the drum before you first use it, to remove any dust which may have accumulated during transit.
4. To load, place the clothes carefully in the drum pushing them well towards the back and clear of the door seal.

5. Close the door firmly so that it clicks. This indicates that the latch has been engaged.

Wash Care labels

Most of today's fabrics can be tumble dried in your Dryer with no trouble at all, but there are certain fabric finishes which should be dried away from direct heat.

A lot of garments now have wash-care labels on them, giving full washing and drying instructions.

These should always be followed carefully, especially when you are drying something for the first time. If you find labels like the following. This is what they mean.



Tumble dry at high heat setting.



Tumble dry at low heat setting.



Do not tumble dry.

Items not suitable for Tumble Drying

- Those containing foam rubber or rubber-like materials or plastic film, eg, pillows, cushions, PVC rainwear, or any other articles which are inflammable.
 - Items contaminated with inflammable substances, eg, petrol, oil, paint, cleaning solvents, wax, creams, cooking fat or oil, or eg, towels contaminated with hair lacquer. Such substances can cause fires when exposed to high temperatures such as in a tumble dryer. For the same reason you must not tumble dry rubber, foam rubber, plastic, plastic foam, nappy pants and liners, polythene and paper.
 - Fibreglass (eg, some types of curtains).
 - Items which have been dry cleaned.
- WARNING: THE DRYER IS INTENDED FOR USE ONLY WHERE WATER SOLUTION IS USED FOR THE CLEANING PROCESS. MISUSE OF A TUMBLE DRYER MAY CREATE A FIRE HAZARD.**
- Woolens. Woolen items need as much care in drying as they do in washing. The movement of the tumble-drying action causes the woolen fibre to shrink and distort (see below).
 - Garments with the ITCL code  - Do not tumble dry.
 - Large bulky items eg, continental quilts, sleeping bags, pillows, cushions, double blankets and large bedspreads. These expand when drying and would prevent air flow through the Dryer.

Items requiring special attention

Wool:

Woolen articles should not be dried in a tumble dryer unless they are labelled 'Superwash', 'Machine-washable' or have the 'May be tumble dried' symbol . If in any doubt do not tumble dry wool. Unlike other materials, the mechanism of wool shrinkage is irreversible, ie, it will not stretch back to its original size and shape.

Very heavy woollens. Although ordinary woollens should NOT be tumble dried, it is possible to part-dry some very thick woollens - such as football socks and heavy-knit fisherman's jerseys- by carefully following these instructions:

1. Put four dry, medium sized turkish towels in the drum, close the door

- and set the Timer Knob to 30 minutes. Close the door to start the programme.
2. Just before the programme enters the 'Cool Tumble' phase, open the door, place the woollens in the warm towels and reset the Timer Knob to 30 minutes.
3. Again, just before the 'Cool Tumble' phase, remove the woollens. This will give a drying time with heat of approx. 15-18 min. You will find that a great deal of moisture has been removed. (Remember that while the items are still warm, they will appear moister than they in fact are.)
4. Gently pull the garments into shape and complete the drying away from direct heat.