

DCO7 accessories

The following items can be used with your DCO7. For further information please see the order form, or visit the Dyson website at www.dyson.com

Hard floor tool

For improved pick-up on hard floors.

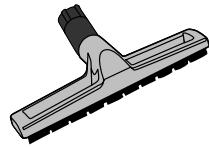

Stubborn dirt brush

With stiff bristles for dried-in and stubborn dirt.



Flexi crevice tool

Extends and flexes into awkward gaps.

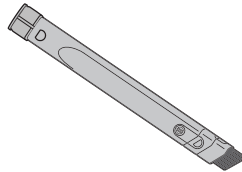

Soft dusting brush

Soft bristles to gently dust around the home.



Mattress tool

Removes dirt and dust mites from mattresses and upholstery.

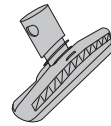

Mini turbine head

Picks up pet hair and dirt from stairs and upholstery.



Low reach floor tool

For easier cleaning under low furniture.

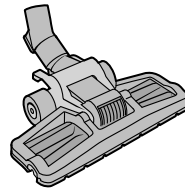

Carpet cleaning kit

Keeps new carpets looking new.

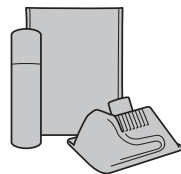

⚠ Important

- The plug must be removed from the socket outlet before cleaning or maintaining the appliance.
- This appliance is not intended for use by young children or infirm persons without supervision.
- On machines without brush control the brushbar spins at all times – even when the machine is upright. Young children should be supervised to ensure they do not play with the appliance, or place body parts near the cleaner head.
- Check that your electricity supply corresponds to that shown on the rating plate. The appliance must only be used as rated.
- If the supply cable of the appliance is damaged, disconnect the appliance from the socket outlet immediately. The supply cable must be replaced by the manufacturer or its service agent

- or a similarly qualified person in order to avoid a hazard.
- Do not use the cleaner if the cable or plug are damaged or if the cleaner has been damaged, dropped or has come into contact with water or any other liquid. In these cases, contact the Dyson Helpline.
- When vacuuming, certain carpets may generate small static charges in the 'clear bin™'. These are entirely harmless and are not associated with the mains supply. To minimise any effect from this, do not put your hand or insert any object into the clear bin™ unless you have first emptied it and rinsed it out with cold water.
- Do not continue to use the cleaner if any part appears to be faulty, missing or damaged.

- Do not carry out any maintenance work other than that shown in this manual or advised by the Dyson Helpline and do not put anything into the openings or moving parts of the machine.
- Only use parts produced or recommended by Dyson; failure to do so could invalidate your guarantee.

European conformity information: a sample of this product has been tested to conform with the following European Directives: 73/23/EEC Low Voltage (Safety) Directive, 93/68/EEC CE Marking Directive and 89/336/EEC EMC Directive.

NB: Small details may vary slightly.

This product is protected by the following Intellectual Property Rights:

CA 1,241,809	AU 2002231965	AU 2002226554
US 4,573,236	CA 2,438,855	CA 2,438,077
CA 2,312,827	EP 1361813	EP 01370173
US 6,536,623	JP 2002-567126	JP 2002-567131
CA 2,313,177	US 2004-0068829	US 6994740
US 6,691,849	AU 287872	AU 2002241151
CA 2,315,078	EP 1320317	CA 2442218
US 6,289,553	JP 2004-509684	EP 1377196
CA 2,325,953	US 7069620	JP 2004-528087
US 6,425,931	AU 2002226556	AU 200225207
US 6,461,508	CA 2,439,250	CA 2,438,069
CA 2,351,252	EP 1370172	EP 1361814
US 6,572,078	JP 4002185	JP 3860541
US 6,442,791	US 6991666	US 7018439
AU 2001232024	AU 2002229966	AU 200225232
CA 2400404	CA 2,439,032	CA 2,438,079
EP 1265519	EP 1361812	EP 1361815
JP 2003-525673	JP 2004-537336	JP 3940082
US 7036183	US 7278181	US 6974488

Design registrations: CA 97332, US D475,820, CA 86192, US D427,737, US D455,242

Equivalent patents, design registrations and applications exist in other countries.

For your safety

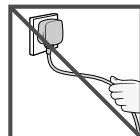

Do not pull on supply cable.

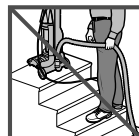

Do not use cleaner above you on stairs.

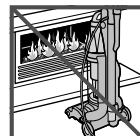

Do not use cleaner near naked flames.

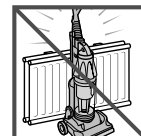

Do not leave cleaner near heat sources.

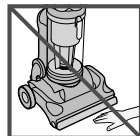

Do not place hands under brushbar when in use.

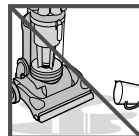

Do not use cleaner to pick up water or any other liquid.

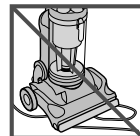

Do not run over supply cable.

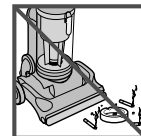

Do not use cleaner to pick up burning objects of any kind.

5 year guarantee

Register now for your free 5 year guarantee



ONLINE

Just visit
www.dyson.co.uk/register



PHONE

7 days a week
(UK) 0800 298 0298
(IRL) (01) 475 7109



MAIL

Complete and return the
freepost registration form



We'll help you choose the right Dyson cleaner and give you any advice and assistance you need when you're using it. You can contact us anytime at www.dyson.com or call our team of experts on UK 0800 298 0298, IRL 01 475 7109 between 7am and 10pm, 7 days a week.

www.dyson.com

Ensure you register for your 5 year guarantee today

After registering for your 5 year guarantee, your Dyson vacuum cleaner will be covered for parts and labour for 5 years from the date of purchase, subject to the terms of the guarantee.

If you have any query about your Dyson, call the Dyson Customer Helpline with your serial number and details of where/when you bought the cleaner. Your serial number can be found on your rating plate which is underneath the machine beneath the wheels or behind the clear bin™.

Most queries can be solved over the phone by one of our trained Helpline staff. If your machine needs attention, we'll aim to send one of our Dyson engineers to fix it within 3 working days. We won't keep you waiting around either: our engineers can visit a home or work address - wherever is most convenient for you.

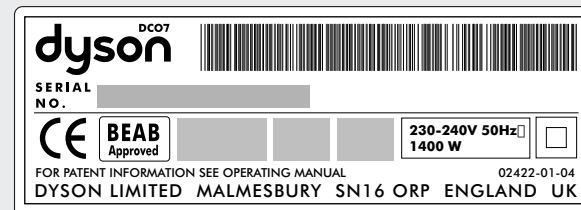

Note your serial number for future reference:

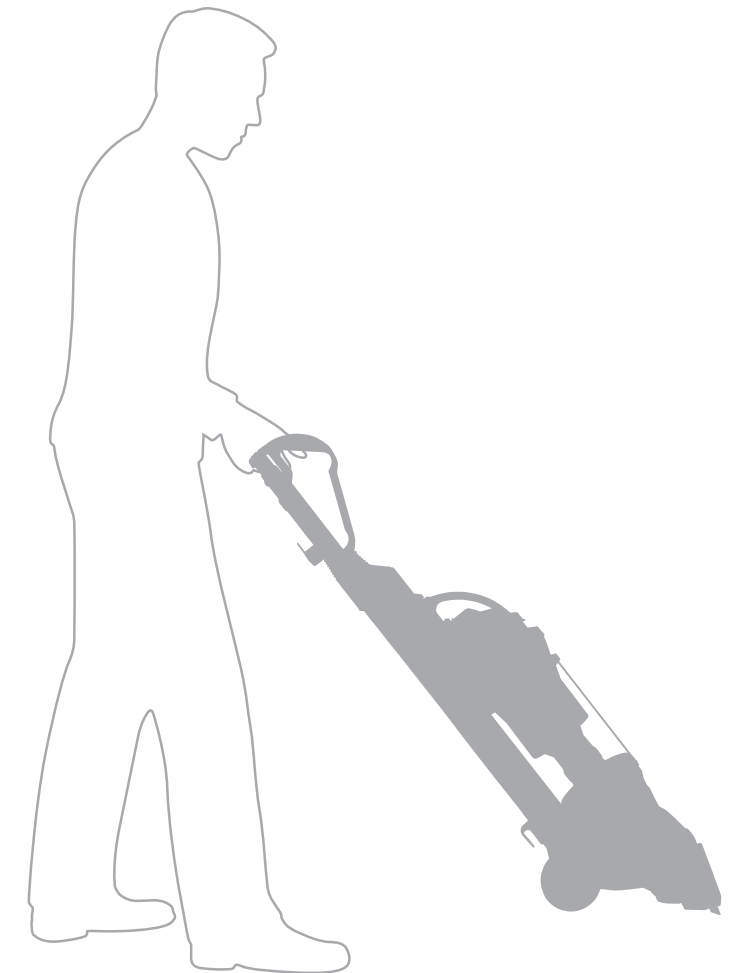
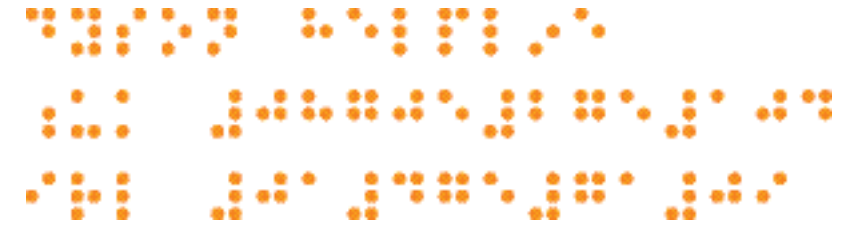

User Guide

Please read this guide carefully before using your DCO7

DCO7

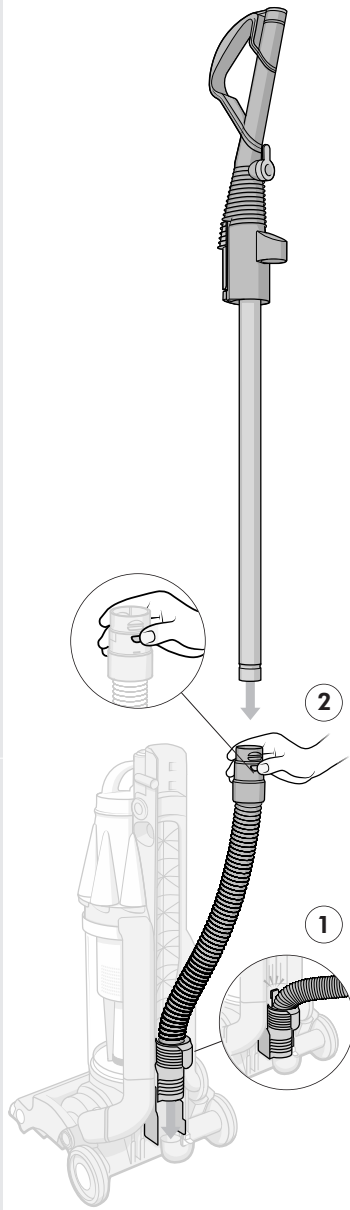
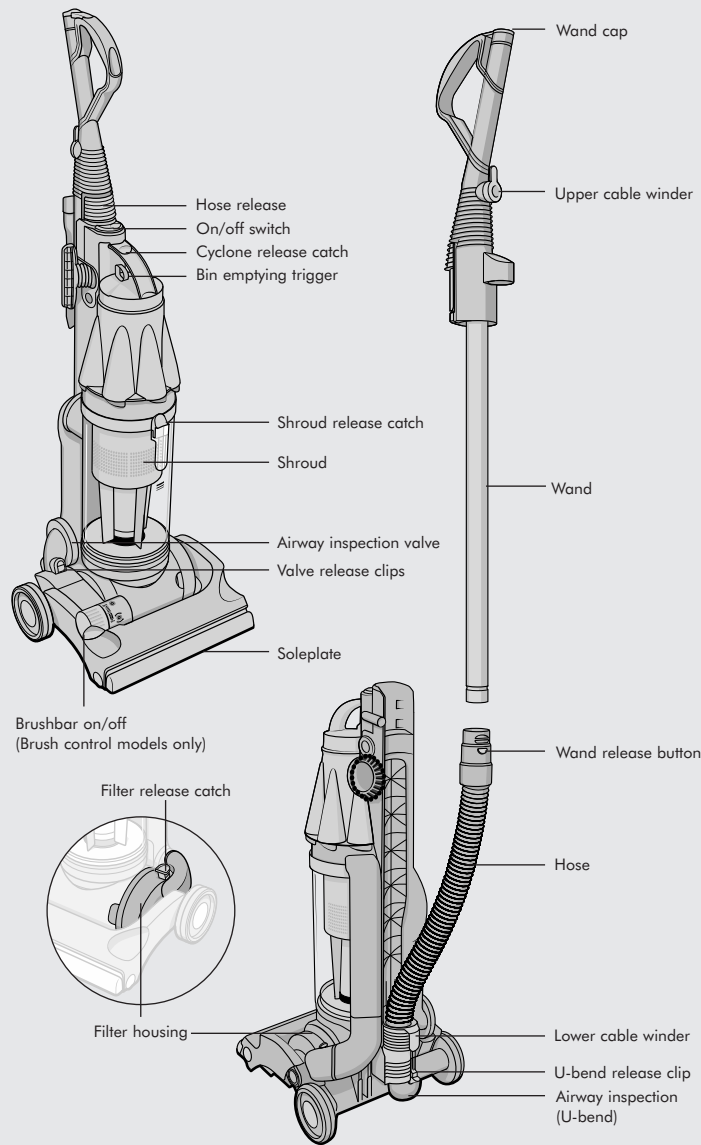
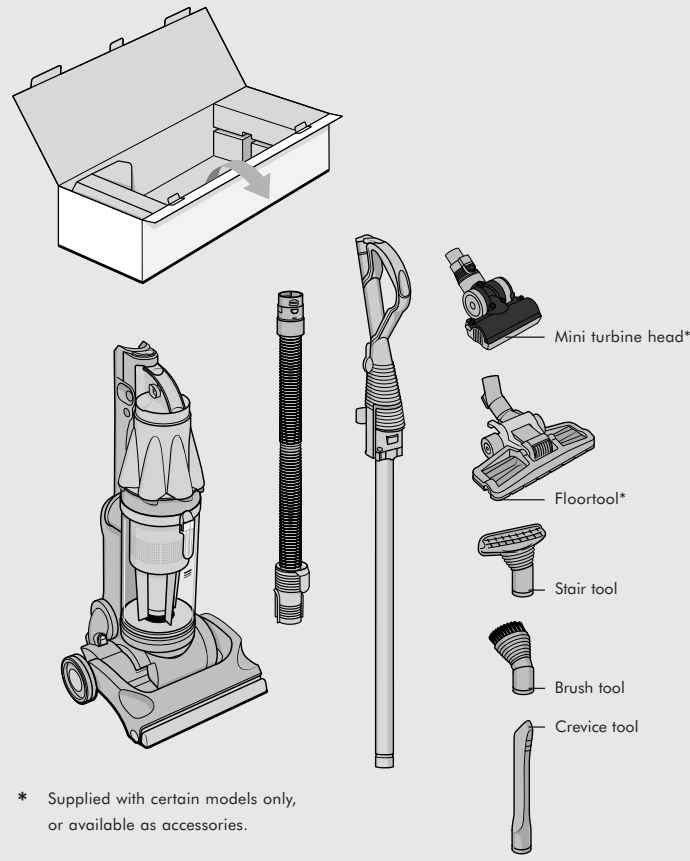

Assembling DCO7

- 1 Slide hose into runners at back of machine, making sure tab clicks into place.
- 2 Press wand release button and slide wand down into hose.

⚠ DCO7 models without brush control are not suitable for hard floors, as the brushbar cannot be turned off. We recommend models with brush control for homes with mixed and hard flooring.

⚠ The ratchet noise warns that the brushbar is obstructed. Disconnect the machine from the electrical outlet before removing the obstruction.

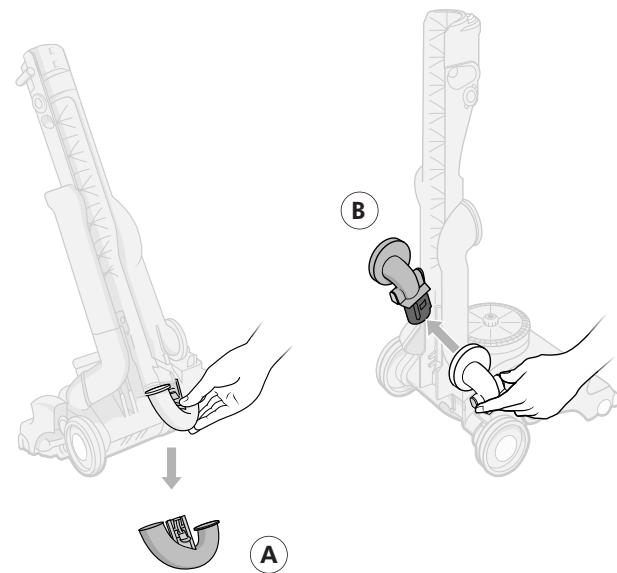

U-bend airway inspection

Tilt machine forward and slide out U-bend airway inspection **A**. Check inside for blockages.

⚠ Make sure all parts have been replaced securely before using your machine.

Airway inspection valve

Squeeze valve release catches to remove airway inspection valve **B**. Check inside for blockages.

Turn power off and unplug before checking for blockages.

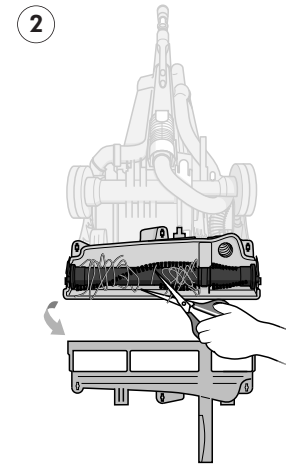
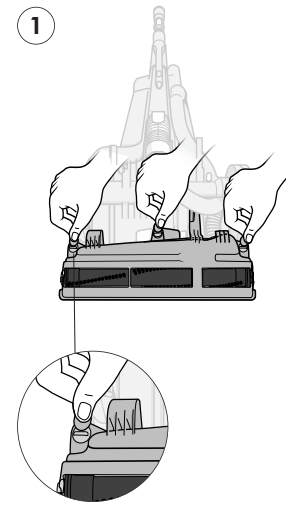
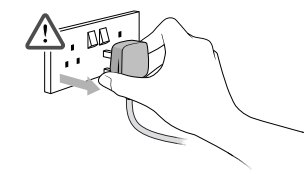

Brushbar

Lie cleaner on its front.

- 1 Undo fasteners using a coin and remove soleplate.
- 2 Clear the brushbar obstruction, carefully cutting away any threads.
- 3 On machines without the brush control the brushbar spins at all times – even when the machine is upright. Young children should be supervised to ensure they do not play with the DCO7 or place body parts near the cleanerhead.

Replace soleplate and tighten fasteners.

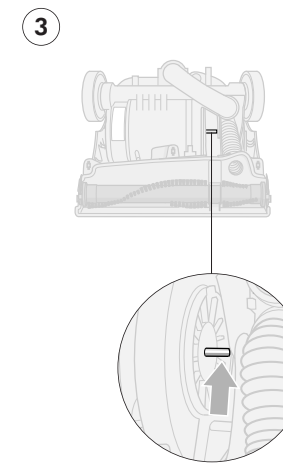
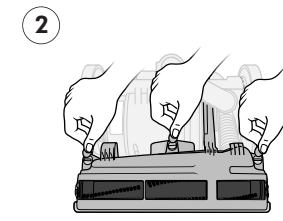
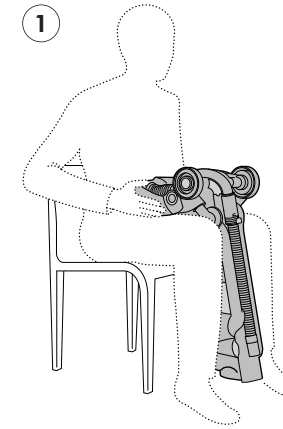

Changing/fitting your belt

(Models without brush control only)

⚠ Allow machine to cool for at least 1 hour before changing/fitting your belt.

- 1 Recommended position for changing the belt, with wand removed.
- 2 Undo fasteners using a coin and remove soleplate.
- 3 Remove any debris and check spindle is clean.

Turn power off and unplug before changing/fitting the belt.

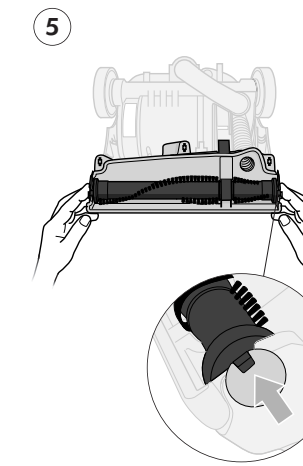
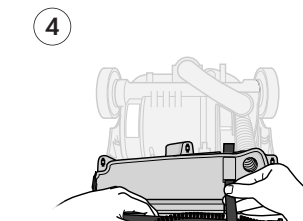
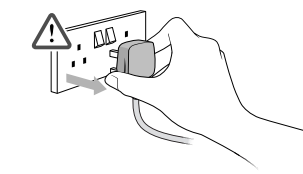

4 To replace the belt – remove brushbar, loop belt around brushbar and feed through hole.

5 Using the back of the cleaner as a lever, loop the belt around your thumb. Turn the belt through 90 degrees. Stretch and release over spindle.

Belt should be free of twists as shown.

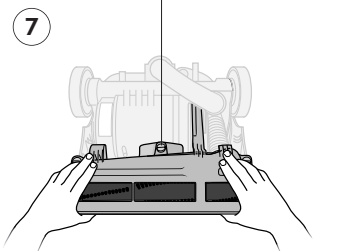
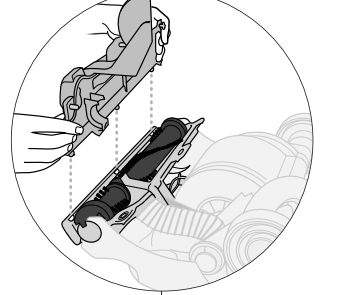
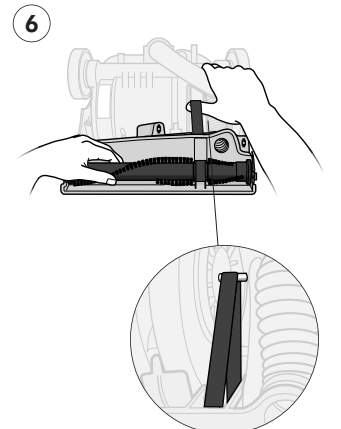

6 Replace the brushbar and check end caps are securely in place.

7 Rest the three tabs on the inside of the bumper strip, before pivoting soleplate into position and tighten fasteners.