

**HOTPOINT
SLOT-IN COOKER**

**USER HANDBOOK AND
INSTALLATION INSTRUCTIONS
MODELS 6531 & 6521**



Hotpoint®

Before you operate your new Hotpoint Slot-In Cooker

Please read these instructions fully.

1. Ensure that the cooker is installed by a qualified electrician following the instructions below.
2. For your own safety and to get the best results from your cooker it is important to read right through this Handbook **before** using your cooker for the first time.
3. Before using the ceramic hob for the first time wipe the ceramic area with the Ceramic Hob Cleaner-Conditioner (Hotpoint Part No. 6004 – obtainable either through a local Hotpoint Service Centre or retailer).

Installation

Siting the Cooker

The cooker is designed to be flush fitted between standard kitchen units spaced a minimum of 600mm apart. The clearance either side need only be sufficient to allow withdrawal of the cooker for servicing. It can be used with cabinets on one side or both, as well as in a corner setting. It can also be freestanding.

Adjacent side walls which project above the hob level should be protected by heat resistant material, but in any case should not be nearer to the cooker than 100mm. Any overhanging surface or cooker hood should not be nearer than 650mm.

Unpacking the Appliance

The cooker should be carefully unpacked and checked for damage. Ensure that no packaging material is left inside the oven cavities.

- Any electrical wiring must be carried out in compliance with the appropriate IEE and electricity board regulations by a qualified electrician, eg. your local electricity board or a contractor who is on the roll of the National Inspection Council for Electrical Installation Contracting (NICEIC).
- **WARNINGS – INCORRECT INSTALLATION COULD AFFECT THE SAFETY OF THE APPLIANCE.**
 - ALL APPLIANCES MUST BE EARTHED.
 - BEFORE CONNECTING OR INSTALLING THE COOKER THE ELECTRICITY SUPPLY MUST BE SWITCHED OFF.
- **IMPORTANT** – The earth connection on this appliance must be made using a box spanner to avoid strain on adjacent terminals.
- The installer **must** check that the voltage shown on the rating plate corresponds with the house electricity supply.
- The cooker **must** be connected to a suitable double pole isolating switch (cooker control unit) having a contact separation of at least 3mm in all poles placed in a readily accessible position adjacent to the cooker.
- To gain access to the mains terminal block to connect the supply cable, the installer **must** remove the mains terminal cover located at the lower right hand side of the rear panel.
- The main cooker control unit **must** be switched **ON** for any part of the cooker to function. In houses fitted with a 30 milliamp RCCB, the combined use of your slot-in cooker and other domestic appliances may occasionally cause the RCCB to trip. In the unlikely event of the RCCB repeatedly tripping contact your local Hotpoint Service Office. In some instances it may be necessary to fit a 100 milliamp RCCB.
- Height adjustment. The cooker is set at its minimum height of 900mm and this can be increased to 915mm by the adjustment of the two feet located at both front corners on the underside of the cooker. Before sliding the cooker into position using the rear wheels measure the height of the units next to the cooker from the floor to the worktop at front and back. Lower top oven door, place hands on top oven roof avoiding any damage to the grill element and carefully locate cooker into position. A second person should hold the cooker whilst it is lifted backwards to gain access to the adjustable feet. To increase height rotate the feet anti-clockwise by hand or use a cross thread short screwdriver. To lower the height rotate the feet clockwise. Wheels are fitted to the rear corners. Check the level of the cooker by placing a spirit level on top of the fascia taking care not to scratch the fascia. Make any adjustments necessary. The maximum loading of your cooker is 11.55kW.

NOTE: Children should not be allowed to play with the appliance or tamper with the controls.

Contents

	page
Before you operate your new Hotpoint Slot-In Cooker	2
The main parts of your Cooker	4/5
Changing the Main Oven door hinging	6
The cooking systems in your Cooker	7
The Controls	8-9
The Timer	10-12
Use and Care of the Ceramic Hob	13-15
Top Oven – Grilling	16
Top Oven – Conventional Cooking	17
Main Oven – Fan Cooking	18
Temperature Conversion Chart	19
Care and Cleaning of the Cooker	20-22
If something goes wrong	23
If it still won't work	23
Hotpoint Service Cover	24
Hotpoint Service Offices and Spares Centres	back page

Retention of this Instruction Book

This Instruction Book must be kept handy for reference as it contains important details on the safe and proper use of the appliance.

If you sell or pass the appliance to someone else, or move house and leave it behind, make sure this Book is also provided so the new owner can become familiar with the appliance and safety warnings.

If the Book is lost or damaged a copy may be obtained from Hotpoint Ltd, Celta Road, Peterborough, PE2 9JB.

The Main Parts of your Cooker

WARNING: DO NOT TOUCH THE OVEN DOORS WHEN THE OVEN IS IN USE AS THESE AREAS CAN BECOME HOT.

MODEL 6531

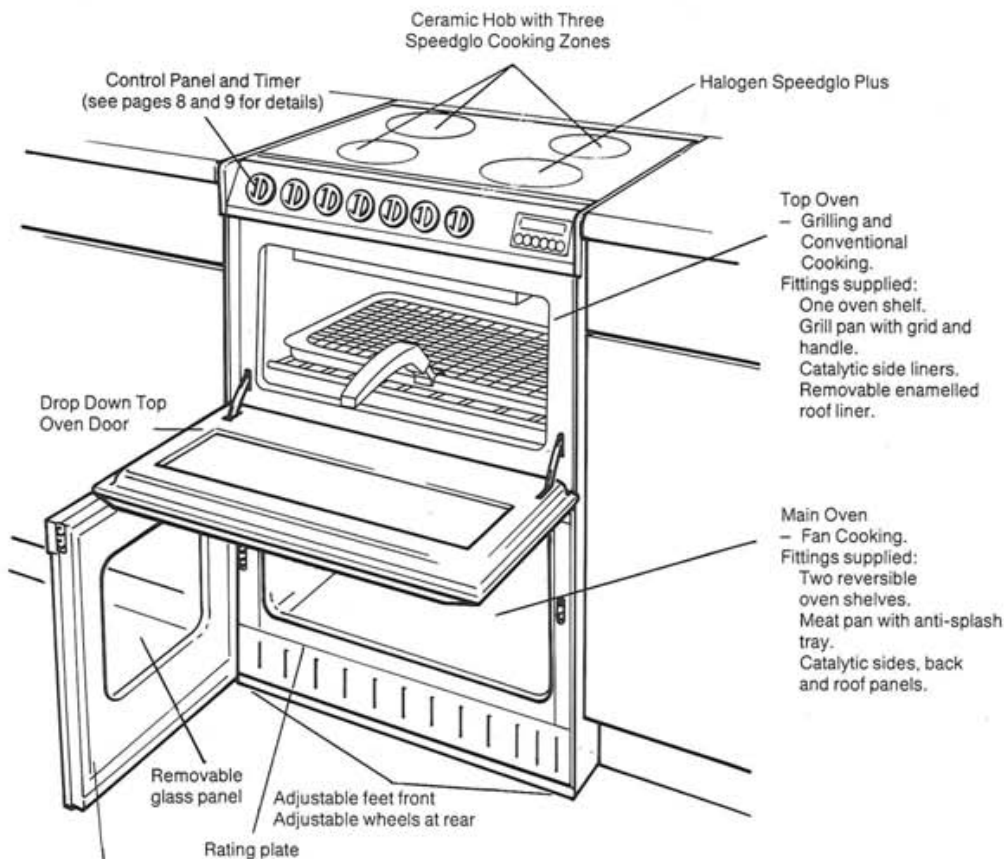

Reversible Main Oven Door (see page 6).

NOTE: When this is opened the fan stops and the heating elements switch off.

NOTE: A fan blows air below the control panel when the main oven is in use.

The Main Parts of your Cooker

WARNING: DO NOT TOUCH THE OVEN DOORS WHEN THE OVEN IS IN USE AS THESE AREAS CAN BECOME HOT.

MODEL 6521

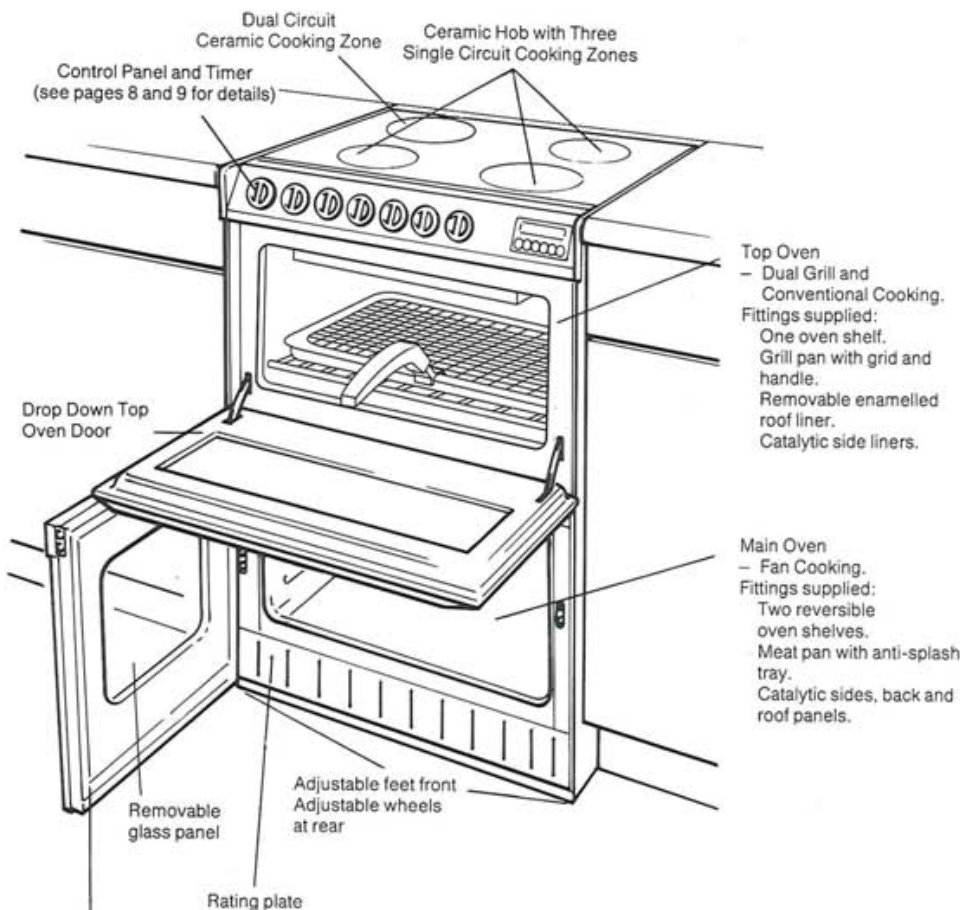

Reversible Main Oven Door (see page 6).

NOTE: When this is opened the fan stops and the heating elements switch off.

NOTE: A fan blows air below the control panel when the main oven is in use.

Changing the Main Oven door hinging

WARNING: Switch off the electricity supply to the cooker at the cooker control unit before changing the door hinging.

A pack of fittings is supplied with the information pack in the cooker. This contains:

- 1: opposite hand moulding
- 50mm double sided tape
- 1: door pull identifier
- 2: flat washers

You will need a No.2 Posidriv screwdriver.

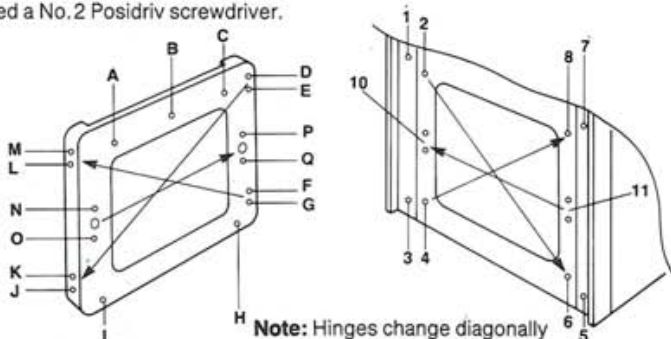

1. Open the door fully. Place padding under the door to support the door during the removal of the hinges.
2. Unscrew screws and remove hinge at positions 1 and 2 and replace at 5 and 6.
3. Unscrew screws and remove hinge at positions 3 and 4 and replace at 8 and 7. **Note:** Replace steel washer on the lower hinge. Only loosely fit screw No. 7 at the top to allow you to slot the door into position. Retain screw No. 8 on one side for use later.
4. Place the door on a flat surface.
5. Remove screws A, B and C, H and I to remove the inner panel from the outer glass and handle.
6. Remove door catch N and O and blanking plate P and Q and replace on opposite sides of the door. A 7 mm spanner may be required.
7. Remove screws M and L holding small corner moulding. Also remove screws D, E, F and G holding door side hinges and replace at J, K, L and M as shown in illustration. **Note:** Hinges replaced diagonally, do this one at a time to avoid confusion.
8. Place small corner moulding from pack at position D, E.
9. Replace the glass and inner panel and replace screws H and I. Place the handle into position and replace screws A, B and C. **Note:** If round door spacers at the handle have become dislodged, replace using the double sided tape provided. Replace all fibre washers.
10. Transfer the door striker from the right '11' side to the left '10' side by interchanging the door striker and upper blanking screw only. Do not remove the adjacent lower screw fixings.
11. Place door on bottom hinge and place top hinge into position. Replace screw No. 8 and tighten screw No. 7.
12. Some adjustment of the door striker may be necessary at this stage. With the door moved to a position where the door catch meets the striker, the striker must be located in the centre of the door catch aperture. If the striker does not locate centrally in the door catch, vertical adjustment may be obtained by slackening the door striker locknut and the posi-screw, then the striker can be moved up or down as required. With the door closed the head of the striker must be fully engaged by the door catch. It is important after changing the door over, to check the door seal by closing the door onto a 2in wide strip of paper (newspaper thickness), there should be resistance to the withdrawal of paper at all points around the seal, if the door seal does not grip the paper, or if it is too tight, adjustment can be obtained by slackening the locking nut on the striker and screwing it in or out as necessary then relocking the nut.
13. Remove the 'door pull' identifier from its original position and reposition it at the end of the handle away from the hinges.

The cooking systems in your Cooker

Your new cooker is equipped with three different cooking systems:

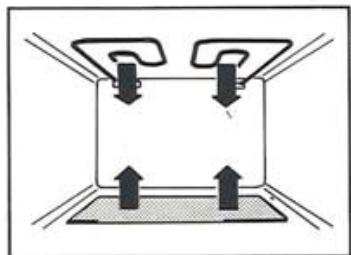

1. **Conventional Heating** [Top Oven] – with upper and lower heat. This system is particularly suitable for roasting and baking on one shelf only.

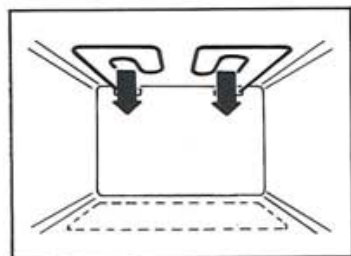

2. **Variable Grilling** [Top Oven] – the oven can also be used for conventional grilling with a full or half width fully controllable grill.
Note: The Top Oven Door should be open when grilling.

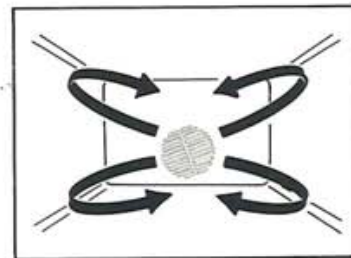

3. **Fan Cooking** [Main Oven] – the fan oven operates by constantly blowing heated air, from an element wrapped around the fan, into the oven. This gives improved efficiency and, in general, enables the use of lower temperatures for cooking. It also means that there is less need to be particular about shelf positions and that you can bake at more than one level simultaneously (Batch Baking).

These three systems of cooking are described more fully in the separate Recipe Book and we would suggest you read right through the Introductory Section of that book **before** using the oven.

PLEASE NOTE that when the cooker is used for the first time a slight odour may be emitted due to the 'burning off' of any temporary finish on oven fittings and elements and the removal of moisture absorbed by the lagging. The odour will cease after a short period of use.

Ensure that the room is well ventilated (eg. open a window or door) and that persons who may be sensitive to the odour avoid any fumes. It is suggested that any pets be removed from the room until the new smell has ceased.

The Controls

Switch on the electricity supply to the cooker at the Cooker Control Unit.

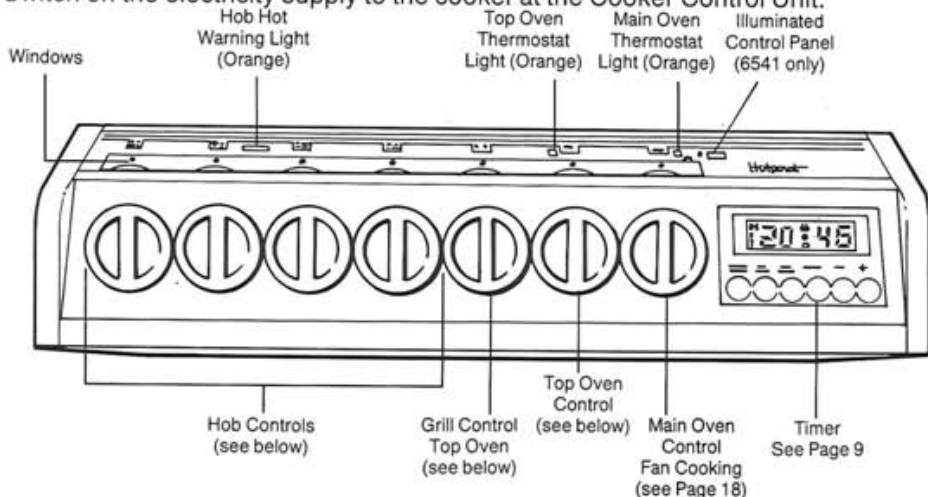

Hob Controls

As each control knob is turned clockwise, figures from 1-6 appear in the window above the control knob.

Setting 6 is the highest/hottest and gives 100% power. Setting 1 is the lowest/coolest and gives about 7% power (see page 12 for ratings). Variable power is obtainable on each of the heating areas by selecting any number between 1-6.

The 'off' position is identified by an 'O'.

The hob hot warning light (orange) will operate soon after any of the heating areas are switched on. It will remain illuminated until the ceramic surface has cooled down and it is safe to touch.

Grill Control – Top Oven

The grill control will not operate unless the top oven control is in the 'O' off position.

The grill control provides fully variable heat control for either the twin grill or single (left hand side) grill by selecting any number between 1-4.

When turned clockwise the twin grill will be switched on and any power setting from 1-4 can be selected. The power level numbers are indicated in light red.

When turned anti-clockwise the single grill will be switched on and any power level from 1-4 can be selected. The power level numbers are indicated in light red.

The 'off' position is identified by an 'O'.

Top Oven Control

This control switches on the top and bottom heating elements in the top oven.

The temperature in the top oven can be set anywhere between 100°C and 220°C.

The orange thermostat light will glow initially and remain on until the oven reaches

the required temperature. It will then cycle off and on as the oven thermostat maintains the correct temperature.

The 'off' position is identified by an 'O'.

Main Oven Control

This control switches on the Main oven.

1. To select Fan Cooking:

Turn the control clockwise and select any temperature between 70°C and 230°C.

As the control is turned the fan will start, the oven interior light and the orange Main Oven thermostat light will come on and the heating element around the fan will start heating.

The fan and oven interior light will remain on throughout cooking.

The orange Fan Cooking neon light will come on and remain on until the oven reaches the required temperature. It will then cycle off and on as the oven thermostat maintains the correct temperature.

Notes

1. **Never** operate **both** the top oven grill control and top oven control together. The grill will not operate unless the top oven control is in the 'O' off position.
2. When the main oven door is opened a switch automatically disconnects the fan and heating element. These are reconnected when the door is closed.
3. If either oven does not switch on when the control is turned check that the timer is in Manual operation.

The Timer and its operation

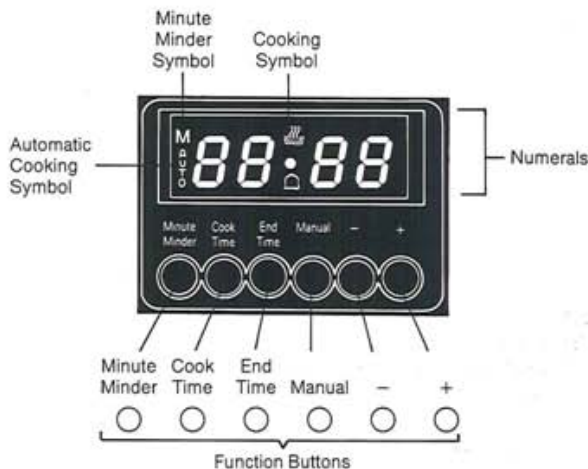

The Timer can be used to automatically switch on either oven independently or both ovens simultaneously. It can also be used as a minute minder and 24-hour clock.

Hints on Automatic Cooking

1. Select foods which will take about the same time to cook, and require approximately the same oven temperature.
2. Foods which discolour should be protected by coating in cooking oil, or tossing in water to which lemon juice has been added.
3. Foods should be well sealed in dishes, to prevent the loss of liquid during cooking. Aluminium foil makes a good seal.

Switching On – manual operation

1. Make sure the cooker is switched **On** at the main cooker control unit.
2. Check that the timer is showing the correct time of day. If you have just switched On, the display will be at 0.00 and flashing.

Setting Time of Day



To set the time of day, press and hold the Cook Time and End Time function buttons simultaneously whilst pressing down the + button. This will advance the display. Should you overshoot the desired time, the display may be turned back by pressing the - button, whilst keeping both function buttons depressed. Both + and - buttons will initially operate slowly but as the button is held, will operate more quickly. Once the time of day has been set, on release of the buttons, the auto symbol will flash. Press the manual button to release the auto symbol and the cooking symbol will be displayed. The clock is of the 24-hour type.

Using the Timer to switch OFF the Oven Automatically



1. Make sure that the time of day is correctly displayed (see page 9).
2. Press and hold down the **cook time** button and the display will show 0.00 with the cook symbol on.
3. Whilst continuing to press the **cook time** button, set the required cooking period using the + or – buttons, eg. setting to 2 hours 15 minutes. On releasing the buttons the **Automatic Cooking Symbol** (AUTO) will show and the display will revert back to the time of day, the Cooking Symbol will remain on. The cooking period has a maximum duration of 23 hours 59 minutes.
4. Turn the oven control(s) to the desired cooking temperature.
5. Place food in the oven.
6. The cooking period will now commence immediately and the oven will be switched off automatically at the end of the selected cooking period. An audible warning will then sound for 15 minutes unless cancelled. The audible warning signal is cancelled and the cooker returned to manual operation by pressing the **Manual** button. The Automatic Cooking Symbol will be removed from the display and the Cooking Symbol  will show.
7. Turn the oven control(s) to the '0' **Off** position when the timer is returned to manual.
8. To use the Timer to switch both top oven and main oven on simultaneously – follow the procedure above, turning both oven controls to the desired cooking temperature.

Using the Timer for a delayed Cooking Operation



- Follow steps 1-3 of the previous instruction then:
4. Press and hold down the **End Time** button (the display will show the earliest possible programme end time).
 5. Whilst continuing to press down the **End Time** button, set the required stop time by using the + button, eg. setting to 13:30. If the desired setting is overshoot, the display can be turned back using the – button.

On releasing the buttons the Cooking Symbol  will be cancelled and the Automatic Cooking Symbol (AUTO) will remain on. After a few seconds the timer will show the time of day.

6. Set the oven control to the desired cooking temperature.
7. Place food in the oven.
8. The oven will switch on automatically after the correct delay period, cook for the required time and switch off automatically at the selected stop time. An

audible warning will then sound for 15 minutes and the Automatic Cooking Symbol will flash unless cancelled.

The audible signal is cancelled and the cooker returned to manual operation by pressing the Manual button. This will also remove the Automatic Cooking Symbol from the display and the Cooking Symbol will show.

- Remember to turn the oven control to '0' Off when timer is returned to manual.
- Both top and main oven(s) can be used for a delayed cooking operation.

To Cancel a Delayed Cooking Programme

An automatic cooking programme once set (see items 1-5 opposite) may be cancelled as follows:

- Press the **Cook Time** button followed by the **-** button, keeping both buttons depressed until the display shows '0.00' with the 'AUTO' symbol still on.
- On releasing both buttons the oven is returned to manual operation by pressing the **Manual** button, which also cancels the Automatic Cooking Symbol. The Cooking Symbol  will now show.

Setting the Minute Minder



- The minute minder is set by pressing and holding down the **Minute Minder** button. The display will show 0.00.
- Whilst continuing to hold down the **Minute Minder** button set the required cook time by depressing the **+** or **-** buttons, eg. setting to 28 minutes. On releasing the **Minute Minder** button the timer will again show the time of day and a bell symbol will appear on the display.

Press and hold down while setting

Press as necessary

- The **Minute Minder** will countdown in minutes until the set period has elapsed, after which the audible signal will sound for 15 minutes unless cancelled by pressing the **Minute Minder** button. During the timed period, the time remaining may be checked by pressing the **Minute Minder** button.

Checking Settings

Any setting or cooking period time remaining may be checked by pressing the appropriate button.

Points to Note

- After setting the timer, if the cooking symbol  is displayed, the oven cannot be used for a delayed cooking operation ie., no stop time has been set.
- If the cook programme has been completed, the Automatic Cooking Symbol (AUTO) will continue to flash until the timer has been returned to manual. This is important because the oven cannot be switched on if the timer is set to 'AUTO' except during the course of a cooking programme.
- When one oven is set to operate on the 'AUTO' timer the other oven cannot be used manually.

Using the Ceramic Hob

WARNING: DO NOT USE THE HOB IF IT IS CRACKED. SWITCH OFF AT THE COOKER CONTROL PANEL IMMEDIATELY AND CONTACT YOUR NEAREST HOTPOINT SERVICE OFFICE (SEE BACK PAGE).

Ratings of Cooking Zones

6541

Front Left	Halogen Speedglo Plus	1200W	145mm diameter
Front Right	Halogen Speedglo Plus	1800W	180mm diameter
Back Left	Halogen Speedglo Plus	1800W	180mm diameter
Back Right	Halogen Speedglo Plus	1200W	145mm diameter

6531

Front Left	Speedglo	1200W	145mm diameter
Front Right	Halogen Speedglo Plus	1800W	180mm diameter
Back Left	Speedglo	1800W	180mm diameter
Back Right	Speedglo	1200W	145mm diameter

The Working of the Heating Zones

Heating only occurs within the marked circular cooking zones.

The zones heat up and cool down quickly providing greater controllability for sensitive foods.

Each heating zone is equipped with a thermal limiter which is a safety cut-out which prevents the ceramic glass from overheating. After several minutes at full, power without a pan on the heating zone the thermal limiter will switch the heating elements off and on automatically to avoid any damage to the ceramic glass.

Choice of Saucepans

It is essential that the saucepans you use on the ceramic hob are suitable.

DO USE:

- Good quality pans with smooth, flat, heavy bases.
- Saucepans manufactured from aluminium (enamelled or machined) or stainless steel.
- Correct size saucepans. The base of the pan must cover the heating zone completely.
- Saucepans with lids which are well fitting to reduce cooking time and energy use.

DO NOT USE:

- Pans with thin, distorted or uneven bases as these will extend cooking times, waste electricity and cause damaging, local hotspots on the glass surface.
- Pans with ridged or recessed bases.
- Pans with damaged or rough bases which could scratch the glass surface.

Care of the Ceramic Hob

In order to keep your Ceramic Hob in good condition follow these simple guidelines:

- **Do not** use the surface for chopping and cutting as this will damage the smooth surface.
- **Do not** cook directly on the surface of the glass.
- **Do not** slide pans across the hob as this could cause scratches. Lift pans when moving them.
- **Do not** leave heating zones uncovered when they are on.
- **Do not** allow aluminium foil or plastic items to come into contact with the hot surface.
- **Do not** place anything between the saucepan base and ceramic glass surface (eg. cooking mats, etc).
- Ensure that the bottom of the pan is both clean and dry. Dirt or moisture between the pan and the hob can cause pitting of the surface of the glass.
- Always cover the heating zone completely with the saucepan.
- Clean spills immediately. (See below for advice.) If the hob is reused before cleaning, spillage will be baked on and be very difficult to remove.
- Take extra care when cooking foods with a high sugar content eg. jam as spillage will cause damage to the surface of the glass.

Cleaning the Ceramic Hob

Always switch the cooker **OFF** at the cooker control panel.

To minimise cleaning always

- Avoid spills.
- Use a Ceramic Hob Cleaner-Conditioner before using hob initially and subsequently whenever cleaning is done. The Cleaner-Conditioner forms a protective film on the hob and contains a mild detergent which makes cleaning easier. Hotpoint has a Cleaner-Conditioner which can be obtained either through a local Hotpoint Service Centre or retailer, part No. 6004.

To clean off stubborn stains the following can be used when the surface has cooled:

1. Jif, non-scratch cream cleaner.
2. Heavy soil can be removed from the surface by **carefully** using a glass scraper.
3. Hard water stains, grease spots and any discolouration having a metallic sheen can be removed with Solvol Autosol Super or any **non abrasive** stainless steel cleaner.

After cleaning, always use the Cleaner-Conditioner and finish it off by polishing with a clean, dry paper towel.

Never use abrasive or chemical oven cleaners as they can damage the surface of the Hob.

The visual effect of any scratches which may occur in use can be minimised by the use of Cleaner-Conditioner. Such scratches cannot be removed but do not affect the function of the hob in any way.

Safety Requirements for Deep Fat Frying

The following recommendations should be followed:

- a) **Never** leave the pan unattended on the heat, eg. to answer the telephone.
- b) Always use a deep pan large enough to cover the cooking zone.
- c) **Never** fill the pan more than one third full with oil or fat. On no account mix oil and fat.
- d) **Do not** overload the pan by trying to fry too much. The pan containing oil and food should **not** be more than two thirds full.
- e) Always dry food thoroughly before frying and lower it slowly into the oil.
- f) **Do not** use a lid on the pan.
- g) Always keep the outside of the pan clean and free from fat and oil.
- h) **Do not** allow excessive splashing of oil onto the hob.

In the event of fire follow these steps:

1. If a saucepan or chip pan catches fire **TURN OFF THE HEAT IF SAFE TO DO SO**, using the switch on the front of the cooker.
2. **DO NOT** attempt to move the pan, this may cause the fire to spread to other areas.
3. **DO NOT** use **WATER** to put out the fire. If available use only an **APPROVED FIRE EXTINGUISHER** for the purpose, ie. **DRY POWDER, CO₂, or HALON.**
4. If a **FIRE EXTINGUISHER** is **NOT** available, smother the flames with a **DAMP CLOTH; SAUCEPAN LID or FIRE BLANKET.**
When smothering the flames **DO ENSURE** that your **FACE AND ARMS** are **WELL PROTECTED** from the flames to save you from becoming hurt.
5. After the fire has been extinguished **DO NOT MOVE OR TOUCH** the pan for at least 30 minutes.
6. If you **FAIL** to put the fire out call the fire brigade immediately.

Top Oven – Grilling

CAUTION: ACCESSIBLE PARTS MAY BECOME HOT WHEN THE GRILL IS IN USE – CHILDREN SHOULD BE KEPT AWAY.

Grilling must be done with the Top Oven door open.

Control knobs may become hot during grilling. The operation of the controls is covered on pages 8 and 9. Remember that the grill will not operate until the Top Oven control is in the 'O' off position.

To operate the grill proceed as follows:

- Open the Grill/Top Oven door.
- When toasting or grilling, the rod shelf with the projections facing upwards should be placed in the second or third runner from the bottom.

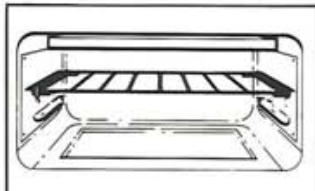

- Preheat the grill on setting 4 for approximately 5 minutes, using either the single (left hand side) or twin width setting depending upon the amount of food to be cooked (see page 8).
- Fixing the grill pan handle. Ensure that the handle is secure before use (see Figs. 1, 2 and 3 below). The food to be cooked should be placed on the grill pan/grill pan grid. Place the grill pan on the shelf and push back until the pan is correctly positioned beneath the grill element.

Note: When positioning the grill pan, for grilling, ensure that the grill pan handles do not become 'caught' in the oven shelf.

Before use ensure grill pan handle is positioned correctly.



- Food which only requires browning should be placed directly on the shelf on the first or second runner from the bottom.
- Leave the control on setting 4 for toast and for the sealing and fast cooking of foods. For thicker foods requiring longer cooking turn the control to a lower setting after the initial sealing on both sides on setting 4. The thicker the food the lower the control should be set.

Warning: Take care as oven/grill will be hot – always wear oven gloves.

ALWAYS ENSURE THAT THE GRILL PAN IS CLEAN BEFORE USE. EXCESS FAT BUILD UP IN THE BOTTOM OF THE PAN COULD CAUSE A FIRE HAZARD.

Fixing the Grill Pan Handle

The grill pan handle is detachable from the pan, to facilitate cleaning and storage. Fix the grill pan handle securely in position before use.

The handle fits onto the grill pan edge with the small recess, Fig. 1.

Tilt the handle over the recess and slide it towards the centre, Fig. 2.

Ensure the handle is fully located, Fig. 3. Insert the washer and fixing screw and tighten fully to ensure handle is secured, Fig. 3.

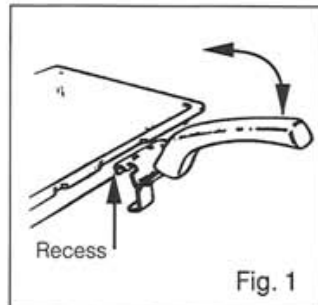

Fig. 1

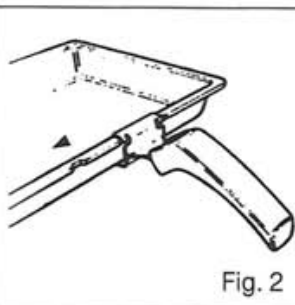

Fig. 2

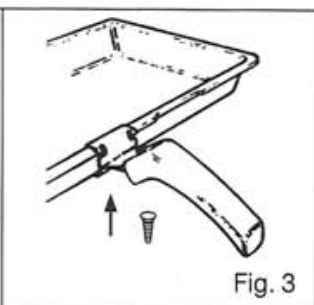

Fig. 3

If detachable handle is required, do not insert screw fixing but retain screw and washer for possible future use.

Top Oven – Conventional Cooking

The heat for conventional cooking in the Top Oven is provided by the grill element and the element under the floor of the oven. It is ideal for the slow cooking of cheaper cuts of meat in casseroles etc but can also be used for small joints of meat up to 1.5 kg (3lb).

The operation of the controls is covered on pages 8 and 9.

Detailed charts covering suggested temperatures and shelf positions for cooking are given in the recipe book supplied.

The Top Oven can be used either independently to cook small quantities of food or in conjunction with the Main Oven to provide additional cooking space.

To use the oven proceed as follows:

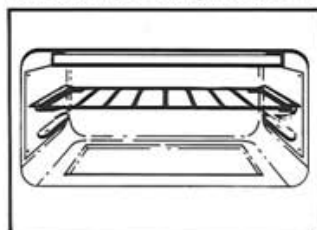

- The shelf should be positioned on the first or second runner from the bottom, and the projections on the shelf should point downwards.
- Set the Top Oven control to the required temperature and wait for the thermostat light to go off indicating that the oven has reached the right temperature.

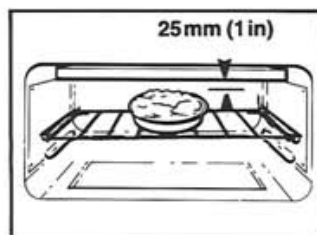

- The food to be cooked should be placed in the centre of the shelf with a gap of at least 25 mm (1 in) between it and the grill element. This should avoid burning and ensure even cooking.
- **Do not place food or dishes on the floor of the oven.**

Platwarming in the Top Oven

Plates and dishes placed on the floor of the Top Oven will be heated when the Main Oven is in use. When the Main Oven is not in use (for instance when a meal is being cooked on the hob) place the plates and serving dishes on the shelf using the bottom runner, and turn the Top Oven control to approximately 100°C. A maximum time of 10-12 minutes is all that is required to heat the plates and dishes.

Do not operate the grill control when using the Top Oven for cooking or for warming plates and dishes.

WARNING: DO NOT PUT DELICATE CHINA OR ITEMS WHICH COULD BE AFFECTED BY HEAT INTO THE OVEN.

Main Oven – Fan Cooking

The heat for Fan Cooking in the Main Oven is provided by an element situated at the back of the oven, around the fan.

Fan cooking is ideal for large poultry or joints of meat, reducing cooking times and often eliminating the need for preheating the oven. It is also ideal for batch cooking where food is cooked on more than one level, because the forced circulation of hot air gives an even temperature from the top to the bottom of the oven.

The operation of the controls is covered on pages 8 and 9.

Detailed charts covering suggested temperatures and shelf positions for Fan Cooking are given in the recipe book supplied.

To use the oven proceed as follows:

- The shelves should be evenly spaced. To avoid unnecessary cleaning, shelves which are not in use should be removed from the oven.
- Set the Main Oven control to the required temperature. Pre-heating is not normally necessary, but some foods such as bread, scones and Yorkshire pudding do benefit from being placed in a hot oven (see recipe book supplied).
- Place the food to be cooked in the centre of each shelf to allow for even air circulation around the food.
- When roasting use the anti splash tray beneath the meat to avoid excessive splashing of the oven.

Temperature Conversion Chart

Conventional Electric		Slot-In Fan Mode	Gas Mark
°F	°C	°C	
200°	100°	80°	1/4
225°	110°	90°	1/4
250°	130°	110-120°	1/2
275°	140°	120°	1
300°	150°	130-140°	2
325°	160°	140°	3
340-350°	170-180°	160°	3-4
350-375°	180-190°	160-180°	4-5
375-400°	190-200°	170-190°	5-6
400-440°	200-225°	190-200°	6-7
450-500°	230-250°	210-220°	8-9

Temperatures

The recommended temperatures given are for conventional and fan ovens. When using a fan oven it will be necessary to reduce the cooking time by 10 minutes per hour, and lower the temperature by up to 30°C. Also, in the majority of cases, it is not necessary to pre-heat the oven. However, pre-heating is recommended when cooking items which require less than 25 minutes cooking time and such items as Yorkshire puddings, whisked sponges and bread. Your experience with the cooker will enable you to select the cooking time and temperature best suited for your recipe.

Condensation

Condensation may become evident on the inner door and water may drip through the vent. This is normal when heat and moisture are present and may be a result of any of the following:

1. Kitchen temperature and ventilation.
2. The moisture content of the food eg. meat, roast potatoes, Yorkshire pudding, roasting meat, etc.
3. The quantity of the food being cooked at any one time.

Care and Cleaning of the Oven

WARNING: BEFORE CLEANING SWITCH THE COOKER OFF AT THE COOKER CONTROL PANEL AND ALLOW IT TO COOL. IT IS ESSENTIAL THAT THE OVENS ARE CLEANED AND KEPT FREE FROM FATS, OIL AND GREASE.

'Stay Clean' Liners

'Stay Clean' liners are covered with a special enamel which absorbs cooking soils. At higher temperatures the soiling is slowly destroyed. In most cases normal cooking at higher temperatures will permit this cleaning to take place automatically.

However, if higher cooking temperatures are not used regularly then it may be necessary, in order to prevent heavy soiling, to run the oven at maximum temperature for at least two hours, from time to time.

The Top Oven roof liner slides out for cleaning.

The 'Stay Clean' liners can be washed in warm soapy water followed by rinsing in clear water. Dry well with a soft cloth.

NOTE: Do not use enzyme washing powder, harsh abrasives or chemical oven cleaners of any kind.

NOTE: Do not grill without roof liner in position.

Oven Fittings

The oven shelves can be cleaned either in a dishwasher or by using a fine steel wool soap pad.

The grill and meat pans can be cleaned in warm soapy water using a fine steel wool soap pad to remove stubborn stains or in a dishwasher. They should be cleaned after each use.

Oven Interiors

To clean the oven interiors remove all oven fittings.

All types of oven cleaners can be used, but **do not** allow abrasive cleaners or oven spray to come into contact with the 'Stay Clean' liners.

Use a fine steel wool soap pad to remove stubborn stains.

Oven Door Cleaning – Main Oven

The inner door glass panel on the Main Oven can be removed for easy cleaning as follows:

- Open the door fully.
- Unscrew the two retaining screws taking care not to lose the two washers fitted underneath the screw head. Also take care not to drop the glass as you are taking it off.

The glass can now be cleaned at the sink. Stubborn stains can be removed with a fine steel wool soap pad.

NOTE: DO NOT use scouring pads or abrasive powder which will scratch the glass.

Take particular care when cleaning the inner surface which is coated with a heat reflecting surface.

After cleaning, rinse and dry with a soft cloth and refit the door:

- Make sure that the face marked 'IMPORTANT. This Face Towards Oven' is facing inwards.
- Refit the two screws with the two washers. Do not overtighten the screws.

WARNING: DO NOT RUN THE OVEN WITHOUT THE INNER DOOR GLASS PANEL FITTED.

Oven Door Cleaning – Top Oven

The Top Oven door is removable for the occasional cleaning of heavy soiling on the oven floor and on the door itself.

To remove, open the top and main oven door fully and, using a coin or screwdriver, turn the two discs anti-clockwise to the position shown below (Fig. a). Part close the door to approx. 45°, unhook the lower hinge fingers upwards, then pull the door away from the body of the cooker.

To replace, insert the lower fingers and hooked ends of the door stays, ensuring that the slots in the lower fingers engage with the front frame (Fig. b). Fully open the door and turn the discs clockwise to their normal working positions (Fig. c).

NOTE: Take care not to trap your fingers. Ensure that assistance is at hand should it be required.

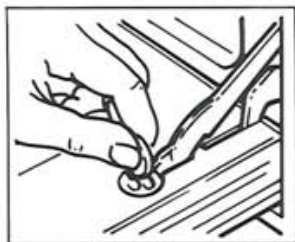

Fig. a

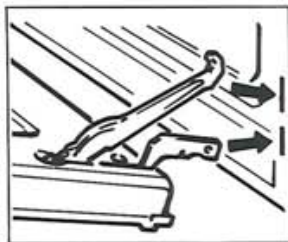

Fig. b

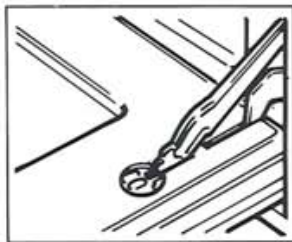

Fig. c

Cleaning the Exterior of the Cooker

The outside of the cooker should be cleaned regularly to keep it looking like new.

Wipe over with a soft cloth wrung out in hot water and dry with a soft clean cloth.

You can use mild non abrasive cleaners but always read the manufacturer's instructions first. Always test their suitability on a small area of the cooker not noticeable in normal use.

NOTE: DO NOT use scouring pads or abrasive cleaners as they may scratch the surface.

Wear protective gloves when cleaning any part of your cooker.

Replacement of the inner, Main Oven light

WARNING: BEFORE REPLACING THE OVEN LIGHT, SWITCH COOKER OFF AT THE COOKER CONTROL PANEL (and allow to cool if it has been used).

Unscrew the glass cover, using a suitable cloth to protect the fingers and remove carefully, ensuring that the metal washer is not mislaid. Unscrew the existing light bulb, and remove. Screw the new bulb into position and replace the glass cover, with metal washer, until positioned securely.

If something goes wrong . . .

First, don't panic! There may be nothing wrong. Check the points below before calling your Hotpoint Service Office.

1. Check that the mains supply is switched on.
2. If the timer is showing **0.00** and is flashing then the power supply has been interrupted and the Timer must be reset (see page 9).
3. Check that the Automatic Cooking Symbol (Auto) on the Timer is not flashing, if it is switch the oven back to Manual control (see page 9).
4. If using the Grill in the Top Oven make sure that the Top Oven Control is set to 'O' Off (see pages 8 and 9).

If it still won't work . . .

Contact the Service Office

If there is still a problem with your Cooker after checking the points above:

1. Switch off the Cooker at the cooker control panel.
2. Call your nearest Hotpoint Service Office or local importer (outside the UK). The telephone number is shown on the back page. Note the number down in the space below:

.....

When you contact us we will want to know the following:

1. Your name, address and post code.
2. Your telephone number.
3. Clear and concise details of the fault.
4. The model number (6541 or 6531) the serial number (situated on the front of the cooker below the main door), and the colour.
5. The date of purchase. Enter the date here:

-
6. If you have taken out one of the Hotpoint Service Schemes.

Please make sure you have all these details ready when you call.

Spare Parts

Please remember your new appliance is a complex piece of equipment.

'DIY' repairs or unqualified and untrained service people may put you in danger, could damage the appliance and might mean you lose cover under Hotpoint's Parts Guarantee.

If you do experience a problem with

the appliance don't take risks; call in Hotpoint's own Service Engineer. The address and telephone number of your nearest Hotpoint Service Office is in your local telephone directory.

Our spare parts are designed exclusively to fit only Hotpoint appliances. Do not use them for any other purpose as you may create a safety hazard.

Hotpoint Service Cover

Satisfaction Guaranteed or Your Money Back

Hotpoint gives you a unique 'Satisfaction Guaranteed' promise – valid for ninety days after you have purchased your Hotpoint product. If there is a problem with your Hotpoint appliance just call your Hotpoint Service Office. If necessary we will arrange for an engineer to call. If the problem is not resolved by us under this Guarantee, Hotpoint will replace your appliance or, if you prefer, give you your money back. This Guarantee is additional and subject to the terms of Hotpoint's Five Year Parts Guarantee.

Hotpoint's Free Five Year Guarantee

From the moment your appliance is delivered, Hotpoint guarantees it for **FIVE YEARS**.

- In the Five Years all replacement parts are **FREE** provided they are fitted by our own Service Engineer. During the first year our Engineer's time and labour is also free.
- After the first year we will charge for our Engineer's time and labour. We do, however, operate a range of Service Plans (see opposite) which for an annual payment enables you to cover any repair costs which may be necessary.
- All of our service repairs are guaranteed for twelve months in respect of our labour and any parts fitted.
- The appliance must be used in the United Kingdom and must not be tampered with or taken apart by anyone other than our own Service Engineer.
- You may, however, buy parts which can be safely fitted without specialist knowledge or equipment. The correct fitting of such parts, provided they are genuine Hotpoint spares, will not affect your Guarantee. Parts are available from our main Hotpoint Spares Centres (see back page).
- Our Guarantee does not cover the cost of any repair which is needed because of power cuts, accidents or misuse. Nor does it cover the cost of any visit to advise you on the use of the appliance. Please read the instruction book thoroughly.
- If at any time during the Guarantee period we are unable to repair your appliance, we will refund any repair costs paid to us in the previous twelve months. We will also offer you a new appliance at a reduced charge instead of a repair.
- Our Guarantee is in addition to and does not affect your legal rights.
- Should you need independent advice on your consumer rights, help is available from your Consumer Advice Centre, Law Centre, Trading Standards Department and Citizens Advice Bureau.

- All Hotpoint servicing is done by our own Service Organisation located throughout the United Kingdom and Southern Ireland. It will be happy to deal with any problems.

Hotpoint's Service Care

Whether you have just one or a number of Hotpoint appliances in your kitchen, Hotpoint has a range of Service Schemes to give you complete peace of mind.

Service Cover

A single payment covers you for all repairs during the period of cover, which can be from 1 to 4 years. There is also an option of Service Cover with Maintenance at an additional cost. This includes an annual Electrical and Safety check and replacement of any parts as necessary. For 1 year contracts this takes place towards the end of the contract period.

Kitchen Cover

An annual payment covers you for all repairs for all your Hotpoint appliances which are less than 10 years old. It also covers the cost of loss of food up to £250 in our refrigeration and freezer products. There is also the option of Kitchen Cover with Maintenance at an additional cost. Any additional Hotpoint appliances purchased after you have joined Hotpoint Kitchen Cover will automatically be included during the annual period of cover without further charge.

Appliance Registration

To ensure that you have the opportunity to benefit from any of the above Service Schemes you should complete and return immediately the Appliance Registration Form supplied with your appliance. Full details and costs of our Service Schemes together with an application form will be sent to you at the end of the first year of the guarantee.

Annual Safety/Maintenance Checks

Hotpoint strongly recommends that all its appliances are regularly checked for electrical and mechanical safety whether or not they are covered by a Service Plan.

Proof of Purchase

For future reference please attach your purchase receipt to this booklet and keep it in a safe place.

Spares and Accessories

Spares and accessories can be ordered from your local Hotpoint Spares Centre (listed on the back page), using the order form enclosed.

Hotpoint Service Offices

SERVICE CALL: If you have a problem with your appliance ring your local Service Office.
SPARES and ACCESSORIES: To purchase spares and accessories send your Accessories Order Form to your Spares Centre. If the accessory or spare part you want is not on the form then contact your Spares Centre for prices and availability.
Please address all correspondence to Hotpoint Spares Centre or Hotpoint Service Office as applicable.

Service Offices and Spares Centres are open between 8.30am-5.00pm Monday to Friday, except on Public Holidays. 8.30am-12.30pm Saturdays

- Service Office and Spares Centre
- Service Office only

EASTERN

- **NORWICH:**
92 Upper St. Giles Street, NR2 1LT.
Tel: Norwich (0603) 620581.
- **PETERBOROUGH:**
Celta Road, PE2 9JB.
Tel: Peterborough (0733) 64741.
- **LUTON:**
5 Crawley Road, LU1 1HX.
Tel: Luton (0582) 452211.
- **ESSEX:**
Industrial Buildings,
Beehive Lane, CM2 9TE.
For postal codes RM; IG
Chelmsford (0245) 492433
Remainder of Essex
Chelmsford (0245) 269331.

EAST MIDLANDS

- **NORTHAMPTON:**
39B Cambridge Street, NN8 1DW.
Tel: Wellingborough (0933) 223669.
- **NOTTINGHAM:** Ashling Street, NG2 3JB.
Tel: Service Office Nottingham
(0602) 862431/864322
Spares Centre Nottingham
(0602) 860387.

LONDON AND SOUTH EAST

- **SUSSEX:** 1 Kingswood, North Street,
Hailsham, BN27 1DQ.
Tel: Hailsham (0323) 842733.
- **WEMBLEY:** 68 East Lane, HA9 7PD.
Tel: Office for S. Herts and Middlesex
081-904 4399
Office for postal codes
W; NW; WC; SW 1, 3, 5, 6, 7, 10
081-904 1250
N; E; EC 081-908 4722
SE and rest of SW 081-908 2511
Spares Centre 081-904 0201.
- **KENT:** Larkfield Trading Estate,
New Hythe Lane, Larkfield, ME20 6SW.
Tel: Service Office Maidstone (0622) 716571
Spares Centre Maidstone
(0622) 716631.

CHANNEL ISLANDS — Service provided by agents
The normal United Kingdom guarantees apply and all services schemes are available.

- JERSEY:** 19 Don Street, St Helier. Tel: (0534) 21625.
- Clos D'Ormes, Pontac, St Clements.** Tel: (0534) 54808.
- GUERNSEY & SARK:** Valoys Stores, Grande Rue, St Martin, Guernsey. Tel: (0481) 38422.
- Lowlands, Braye Road, Vaie, Guernsey. Tel: (0481) 48264.
- ALDERNEY:** 32 High Street, Alderney. Tel: (0481) 822686.

Spares and accessories may be ordered from Hotpoint Spares Administration Dept., Celta Road, Peterborough, PE2 9JB.
Tel: Peterborough (0733) 68989.

In accordance with its policy of progressive product design,
the Company reserves the right to alter specifications.

Hotpoint Ltd, Peterborough, PE2 9JB, England

NORTH EAST

- **NEWCASTLE:**
31 Mosley Street, NE1 1YF.
Tel: Newcastle 091-2321088
- **HULL:** Custom House Building,
Whitefriargate, HU1 2EU.
Tel: Hull (0482) 224777.
- **WETHERBY:** Sandbeck Lane, LS22 4TW.
Tel: Service Office Wetherby
(0937) 581261/581444
Spares Centre Wetherby
(0937) 581221.

NORTH WEST

- **KENDAL:** 2B Highgate, LA9 4SX.
Tel: Kendal (0539) 724483.
- **PRESTON:** 24/25 Cannon Street,
PR1 3NR. Tel: Preston (0772) 824311.
- **MERSEYSIDE:** 40 Cowley Hill Lane,
WA10 2AD. Tel: St Helens (0744) 35152.
- **MANCHESTER:** 44/46 Station Road, Heaton
Mersey, Stockport, SK4 3QT.
Tel: Service Office 061-442 8677 (South)
061-432 0513 (North)
Spares Centre 061-432 0255.

SCOTLAND

- **ABERDEEN:** Holbeck House,
68 Carden Place, Aberdeen, AB1 1UL.
Tel: Aberdeen (0224) 642283.
- **EDINBURGH:**
35 West Bowling Green Street,
Leith, EH6 5NX.
Tel: 031-554 1431.
- **RENFREW:** West Lodge Road,
Blythswood Estate, PA4 9EN.
Tel: Service Office 041-886 6241
Spares Centre 041-886 5511.

SOUTH WEST

- **PLYMOUTH:**
69 Mutley Plain, PL4 6JH.
Tel: Plymouth (0752) 262631.
- **SOUTHAMPTON:**
South Hampshire Industrial Park,
Salisbury Road, Totton, SO4 3SA.
Tel: Service Office Totton (0703) 861981/
667374
Spares Centre Totton (0703) 867933.

WALES

- **NORTH WALES:**
Conwy Road, LL31 9RZ.
Tel: Deganwy (0492) 582626.
- **SOUTH WALES:**
18 Western Avenue, Bridgend Industrial Estate
CF31 3SL.
Tel: (0656) 664121 for postal codes
CF, SA, SY23-25 (0656) 655554 for
BS, GL (not 55), HR, SY15-18, LD1-8, NP
Spares Centre South Wales (0656) 766111.

WEST MIDLANDS

- **STOKE ON TRENT:**
West Avenue, Nelson Estate, Talke,
Stoke on Trent, ST7 1TN.
Tel: Stoke (0782) 774511.
- **BIRMINGHAM:**
Westgate, Aldridge, West Midlands, WS9 8UX.
Tel: Service Office Aldridge (0922) 743374
Service Office for Postal Codes
B (0922) 743374
All other postal codes (0922) 743376
Spares Centre Aldridge (0922) 743377.

IRELAND

- Northern Ireland:** 256 Ormeau Road, Belfast,
BT7 2FZ.
Tel: Belfast (0232) 647111.
- **Eire:** 49 Airways Ind Estate, Dublin 17.
Service Office Dublin 426088
Spares Centre Dublin 426836.
Spares and accessories may be ordered from
either address.