

HOTPOINT SERVICE OFFICES

If you have any trouble with your appliance, please call whichever of these numbers you think is applicable. It does not matter if you guess wrong: we'll make sure that the nearest Hotpoint Service Office tackles the problem.

NORTH EAST

N. Humbs, E. Yorks:
Custom House Building, Whitefriargate, Hull
Tel: Hull 224777

S. Yorks:
Morphy Richards, Marketburgh, South Yorkshire
Tel: Marketburgh 582831

N. & W. Yorks:
Sandwick Lane, Wetherby, West Yorkshire
Tel: Wetherby 61444/6281

S. Durham, Clevel. d.:
59 Albert Road, Middlesbrough
Tel: Middlesbrough 248436

N. Durham, Tyne & Wear, N. Thimberd. d.:
24 Northumberland Road, Newcastle upon Tyne
Tel: Newcastle 32 0008

NORTH WEST

Cumbria, Lancaster:
10 Ship Road, Kendal, Cumbria
Tel: Kendal 24483

Lancashire:
24/25 Carlton Street, Preston, Lancashire
Tel: Preston 24311

Greater Manchester:
4, 60 Station Road, Heaton Mersey, Stockport
Tel: 061 442 8677

Merseyside:
49 Conroy Lane, St. Helens, Merseyside
Tel: St. Helens 35152

Cheshire, Wirral:
Cranshawe, Wirral
Tel: 051 366 2141

1. Cheshire, Wirral, Cheshire Port, South Wirral

S & W MIDLANDS

Herefordshire:
3/9 Brimington Hill, Brimington, Bristol
Tel: Bristol 714471

Berks, Bucks, Oxon:
224 Brookway, Didcot, Oxon
Tel: Didcot 817711

Staffs, Shropshire:
West Avenue, Nelson Estate, Tulse, Stoke on Trent
Tel: Kidsgrove 74511

Worce, B. Ham, W. Mids:
Weslegate, Aldridge, W. Midlands
Tel: Aldridge 55841/55861

E. MIDLANDS

Leics:
De Montfort House, Belgrave Gate, Leicester
Tel: Leicester 29936

N. Lincs, S. Humbers:
Firth Road, Lincoln
Tel: Lincoln 33611

S. Lincs:
Celia Road, Filton, Peterborough, Cambs
Tel: Peterborough 64741

Northants, Warwicks:
398 Cambridge Street, Wellingborough, Northants
Tel: Wellingborough 223659

Notts, Derby:
Ashling Street, Nottingham
Tel: Nottingham 862431

EASTERN

Beds N. Herts:
5 Crawley Road, Luton, Beds
Tel: Luton 452111

Northfolk, Suffolk:
92 Upper St. Giles Street, Norwich
Tel: Norwich 20581

Cambs, Hunts:
Celia Road, Filton, Peterborough, Cambs
Tel: Peterborough 64741

Essex:
Industrial Buildings, Beehive Lane, Chelmsford, Essex
Tel: Chelmsford 289331

LONDON & SOUTH EAST

Middlesex, S. Herts:
68 East Lane, Wembley, Middlesex
Tel: 01 908 1933

London:
88 East Lane, Wembley, Middlesex
Tel: 01 904 1250

Surrey:
2 St. Nicholas Road, Sutton, Surrey
Tel: 01 643 0921

Sussex:
1 Kingswood, North Street, Hailsham, Sussex
Tel: Hailsham 842733

Kent:
Larkfield Trading Estate, New Hythe Lane, Larkfield, Kent
Tel: Maidstone 76571

SOUTH WEST

Glouce, Avon, Wilt, Somerset:
3/5 Bishopsgate Hill, Brimsington, Bristol
Tel: Bristol 714471

Devon:
200 Mill Park, Plymouth
Tel: Plymouth 262331

Hampshire, Dorset:
South Hampshire Industrial Park, Salisbury Road, Totton, Hants
Tel: Southampton 861981

SCOTLAND

Grampian, Highlands:
Hobcock House, 68 Garden Place, Aberdeen
Tel: Aberdeen 6422283

Tayside, Fife, Perth:
Bannerhan House, South Tay Street, Dundee
Tel: Dundee 28838

Central, Lothians, Borders:
West Bowling Green Street, Leith, Edinburgh
Tel: 031 554 1431

Strathclyde, Dumfries, Galloway:
West Lodge Road, Byreswood Estate, Renfrew
Tel: 041 886 6241

WALES

North Wales:
Conwy Road, Llandudno, Junction
Tel: Deganwy 82636

Mid & S. Wales:
18 Western Avenue, Bridgend Industrial Estate, Bridgend, Mid-Glamorgan
Tel: Bridgend 64121

IRELAND

Northern Ireland:
286 Ormeau Road, Belfast 7
Tel: Belfast 647111

Eire:
33/36 Arvan Quay, Dublin 7
Tel: Dublin 729292

Sometimes a number is changed when an edition of this booklet is still current. So if you get no reply from one of these, either try another of the numbers shown here, or see under Hotpoint in your telephone book.

Hotpoint

Hotpoint Ltd., Peterborough, England, PE2 9JB

366307



Hotpoint Handbook

for your Built-Under Oven,
Electric or Gas Hob

Models

61350, 61330, 63660, 63510, 63516, 63210, 64730 & 64736

Hotpoint

Your new appliance

Using your new oven or hob is easy. Nevertheless, to get the very best results it is important to get to know your new appliance by reading right through this handbook **before** using your oven or hob for the first time.

For installation into your housing unit or worktop, please see the separate handbook and do make sure that any electrical wiring is carried out by a qualified electrician and any gas connections are made by an authorised gas fitter.

The handbook covers the following models:

- Model 61330** — Built-Under Oven with controls for electric or ceramic hob.
- Model 61350** — Built-Under Oven with controls for gas hob.
- Model 63660** — Four Plate Ceramic Hob. Can be installed on top of the Built-Under Oven Model 61330 or in conjunction with the Control Panel Model 63210.
- Models 63510** — Four Plate Electric Hob. Can be installed on top of the Built-Under Oven Model 61330 or in conjunction with the Control Panel Model 63210.
- Model 63210** — Control Panel for use with Models 63660, 63510 or 63516.
- Models 64730** — Four Burner Gas Hob without controls for installation on top of the Built-Under Oven Model 61350 only.

ACCESSORIES AND ORDERING THEM

Orders for accessories and spares should be sent to one of the Hotpoint Service Centres shown below.

For normal Service calls you should contact your nearest Hotpoint Service Office shown on the back of this Handbook.

Hotpoint Limited, West Lodge Road, Renfrew, Glasgow, PA4 9EN
Tel: 041-886 5611

Hotpoint Limited, Sandbeck Lane, Wetherby, LS22 4TW
Tel: 0937 61221

Hotpoint Limited, 44/46 Station Road, Heaton Mersey, Stockport, SK4 3QT
Tel: 061-432 0255

Hotpoint Limited, Ashling Street, Nottingham, NG2 3JB
Tel: 0602 860387

Hotpoint Limited, Westgate, Aldridge, W. Midlands, WS9 8UX
Tel: 0922 55866

Hotpoint Limited, Spares Administration Dept., Celta Road, Peterborough, PE2 9JB
Tel: 0733 68989

Hotpoint Limited, 18 Western Avenue, Bridgend Industrial Estate, Bridgend, Mid-Glamorgan, CF31 3SL
Tel: 0656 64127

Hotpoint Limited, East Lane, Wembley, Middx, HA9 7PQ
Tel: 01-904 0201

Hotpoint Limited, Larkfield Trading Estate, New Hythe Lane, Larkfield, Kent, ME20 6SW
Tel: 0622 76631

Hotpoint Limited, Unit R, South Hampshire Industrial Park, Salisbury Road, Totton, Southampton, SO4 3SA
Tel: 0703 867933

FIVE YEAR GUARANTEE

From the moment your Oven and/or Hob is delivered Hotpoint guarantee it for FIVE YEARS. During the five years all parts are completely free of charge provided they are fitted by Hotpoint's own Service Engineer. Labour costs are chargeable after the first year.

This guarantee does not cover accidents or negligence. The appliance must be used in the United Kingdom and must not be tampered with or taken apart by anyone who is not an authorised Hotpoint representative. Hotpoint's guarantee in no way limits your legal rights.





Service is provided by Hotpoint's own service organisation. Should you have any problems simply telephone your nearest Service Office, the address for which is shown on the back of this handbook. Please attach your purchase receipt to this handbook and retain in a safe place.

In accordance with its policy of progressive product design, Hotpoint reserves the right to alter specifications.

If your Oven or Hob won't work

... don't panic.

Just quickly check these points before calling a Hotpoint engineer.

1. Check that the mains supply has been switched on.
 2. If the Electronic Clock Display is flashing  the power supply has been interrupted, to reset the clock see page 6.
 3. Check that the Time Control has been set to  (Manual) operation and not left on automatic (see page 6).
 4. Have you turned both the Function Selector  and the Oven Thermostat  to the appropriate positions?
 5. If grilling have you turned the Oven Thermostat to  and the Variable Grill Control to the required setting?
 6. The Electric or Ceramic Hobs — If the hotplates or cooking zones are not giving the amount of heat you require check that you are using the correct setting (see pages 15, 16).
 7. The Ceramic Hob — If food takes a long time to cook check that the base of the pans you are using are completely flat.
 8. The Gas Burners — If the flame is irregular check that the burner top has been properly located (see page 19). If the burner fails to ignite properly check that the igniter is clean (see page 21).
- If, after following these instructions, your oven or hob still won't work properly, call your nearest Hotpoint Service Office. The telephone number is shown on the back page of this handbook.
1. When you contact us we will want to know your name, address, post code, telephone number and details of the fault.
 2. We will want to know the model number (61350, 61330, 63660, 63510, 63516, 63210, 64730 or 64736) and when the appliance was purchased. Please put the date here:
 3. Meanwhile, switch off the appliance at the mains supply and leave it alone until the Engineer calls.

Contents

	Page
THE BUILT-UNDER OVENS	4
The different heating systems	
Get to know the main parts of your Built-Under Oven	5
Before using your oven for the first time	6
The controls	7
The Automatic Oven Timer	
Minute Minder	
Cooking in the Oven	10
Baking and Roasting using conventional heat	
Fan Assisted Cooking – Baking, Defrosting	
Fan Assisted Grilling – Roasting	
Grilling	
Warming Dishes	
Temperature Conversion Scale	14
THE HOBS	15
Electric	15
The Controls	
The Rear Hotplates on the Electric Hobs	
and all the Cooking Zones on the Ceramic Hob	
The Front Automatic Fast Heat Plates on the Electric Hobs	
Using the Correct Pan	
The Ceramic Hob – Dual Cooking Zones	
Cooking on the Ceramic Hob	
Gas	18
The Controls	
Ignition	
Flame Failure Device	
Cooking	
CARING FOR YOUR OVEN AND/OR HOB	20
The Oven	20
Cleaning the Outside	
Stay Clean Liners	
Cleaning the Oven Door	
Cleaning the Interior	
How to replace the Oven Light	
The Hobs	21
Stainless Steel and Enamel Hobs	
Hotplates	
Gas Burners	
The Ceramic Hob	
If your Oven and/or Hob won't work	22
Accessories and ordering them	23
Your Guarantee	23
Hotpoint Service Offices	24

The Built-Under Ovens

Models 61330 and 61350

Your new oven is equipped with four different heating systems:

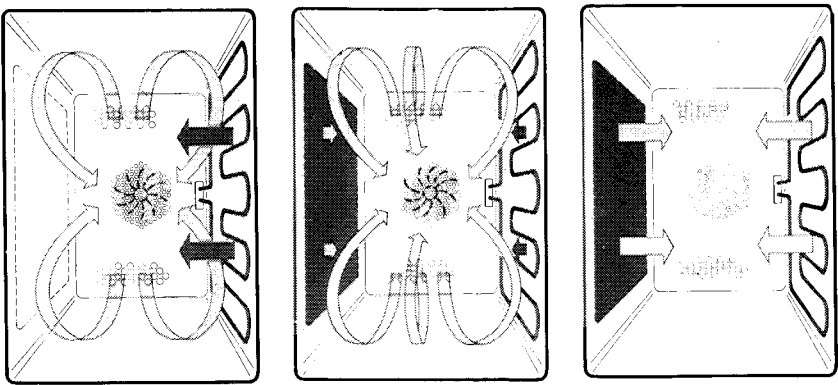

1. **Conventional Heating**  – with upper and lower heat. This system is particularly suitable for roasting and baking on one shelf only.

2. **Fan Assisted**  – the fan oven operates by constantly moving heated air around the oven. This gives improved efficiency and, in general, enables the use of lower temperatures for cooking. It also means that there is less need to be particular about shelf positions and that you can bake at more than one level simultaneously.

3. **Fan Assisted Grilling**  – this is a combination of heat from the grill element and hot air circulated by the fan. Joints of meat and poultry will be browned as if they were cooked on a rotisserie or spit but more economically as the door is left closed.

4. **Variable Grilling**  – the oven can also be used for conventional grilling with a full width, fully controllable grill.

These four systems of cooking are described more fully in the separate Recipe Book and we would suggest you read right through the Introductory Section of that book **before** using the oven.

THE HOBS

Stainless Steel and Enamel Hobs

Wipe these over with a damp soapy cloth followed by rinsing and drying with a soft cloth but remember that some permanent discoloration may occur due to the high temperatures. Stubborn stains can be removed by using a liquid cleaner, e.g. Jif, and, on the stainless steel model, occasionally the use of a proprietary stainless steel cleaner will help to reduce discoloration. Do not use scouring pads or abrasive powder as these will scratch the surface.

Electric Hotplates

Any spillage should be removed as soon as possible to prevent burning on. Use a damp soapy cloth to wipe the hotplates. Anything burnt on should be removed using a nylon scouring pad, e.g. Scotchbrite, steel wool or a proprietary solid hotplate cleaner. Rub a spot of oil onto the plates occasionally to maintain them. Do not use any cleaner which contains bleach.

The Gas Burners

It is important that the thermosensors, igniters and holes in the burner tops (see page 19) are kept clean. When wiping the hob and burners over take care not to bend the thermosensor.

In the case of slight soiling this will be removed in subsequent cooking. Where there is heavy soiling turn the burner to the small flame setting after cooking is finished and the tops will gradually clean themselves. Alternatively clean the tops by brushing carefully with a stiff dry brush. If the tops are removed make sure that they are replaced correctly, i.e. the marking on the burner top is in line with the igniter (see page 19).

The Gas Grids

Lift off for cleaning and wash in hot soapy water, rinse and dry. Stubborn stains can be removed using a fine steel wool soap pad. They can also be cleaned in a dishwasher.

The Ceramic Hobs

Wipe up spills and splashes immediately, so that they do not become burnt on. This is particularly important in the case of sugar and sugar solutions as damage can occur to the hob surface. For daily cleaning use a liquid cleaner, e.g. Jif. Do not use any abrasive cleaner which could scratch the surface. Never put cooking foil or plastic items onto the hot cooking surface. Should these substances accidentally be burnt onto the hob it is essential to remove them immediately to avoid damage.

To build up protection and keep the surface looking like new we recommend the weekly use of a Ceramic Hob Cleaner-Conditioner. This is available from any Hotpoint Service Centre (see page 23) under Part No. 630001. Regular use of a Cleaner-Conditioner will make future cleaning easier.

If heavy solids are burned onto the surface (e.g. boiled over milk) these can be removed, when the surface is cool enough, by careful use of a stainless steel razor or similar blade in a holder, followed by cleaning with a Conditioner.

After cleaning with Conditioner wipe the hob with a clean paper towel. This removes any film or specks of cleaner left on the surface, which would show up as dark specks or 'stains' next time the surface is heated.

Caring for your Oven and/or Hob

Before doing any cleaning always check that the electricity and gas supply to the appliance are turned OFF.

THE OVEN

Cleaning the Outside

Clean the outside by wiping down with a damp cloth using a small amount of detergent, followed by wiping down with a dry clean cloth. Never use an abrasive powder as this will damage the surface.

Cleaning the Oven Door

The door can be removed for cleaning. To do this, open the door and swing the hinge step upwards. Close the door as far as the 'stop' position. Lifting the door slightly, pull it, complete with hinges, away from the oven housing.

Stubborn stains on the inside of the door can be removed by using a liquid cleaner, e.g. Jif. During cleaning the door must not be immersed in water. Do not use scouring pads or abrasive powder which will scratch the glass. Cleaners which contain bleach should also not be used as they may dull the surface. After cleaning, rinse and dry with a soft cloth.

'Stay Clean' Liners

The back of the oven is fitted with a 'Stay Clean' Liner which absorbs cooking soils. 'Stay Clean' side panels and roof are available as an optional extra (Part No. 613164). These are available from any Hotpoint Service Centre (see page 23).

At high temperatures the special surface enables these soils to be slowly destroyed. The higher the temperature the more effective this will be. In most cases this cleaning operation will take place during cooking.

However, if higher cooking temperatures are not regularly used then it may be necessary, in order to prevent heavy soiling, to run the oven from time to time at a higher setting of 250°C for a couple of hours.

Cleaning the floor, sides and roof (if not fitted with optional 'Stay Clean' liners) of the oven, meat pan and shelves

Use a fine steel wool soap pad to remove stubborn stains from the wire shelves, meat pan, floor, sides and roof of the oven. Rinse and dry with a soft cloth.

Note: Abrasive cleaners or an oven spray or pad should not be allowed to come into contact with the oven surround or trims.

How to replace the oven light

Should the oven light fail to work, **switch off** the mains supply to the oven. Access to the bulb can be gained after first removing the lamp cover by turning anti-clockwise. The bulb can then be unscrewed and replaced by one of a similar type (Part No. 613002) which can be obtained from your nearest Hotpoint Service Centre (see page 23).

Get to know the main parts of your Oven

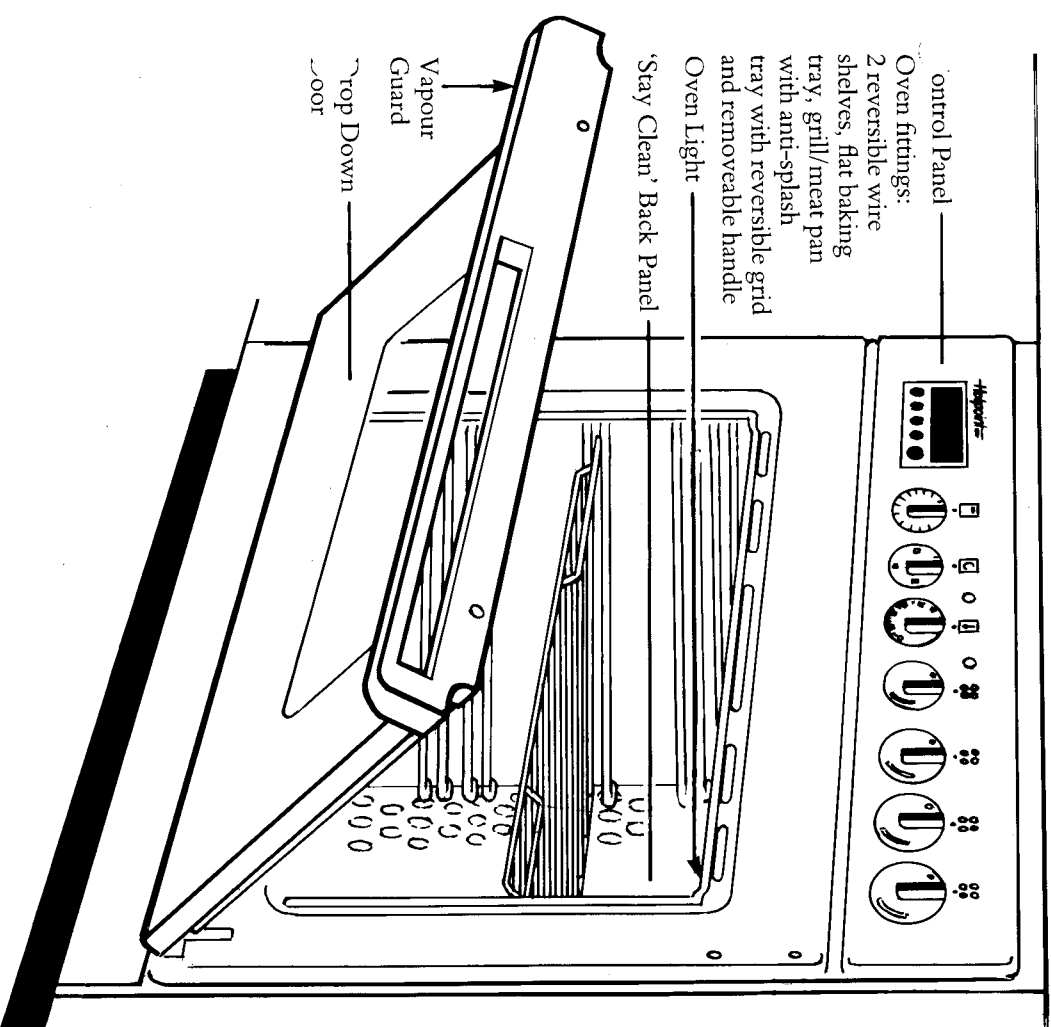

Before using your Oven for the first time

In some models the shelf racks will have to be inserted. To do this first push the long ends of the racks into the top openings in the side walls and then insert the bottom ends in the holes provided.

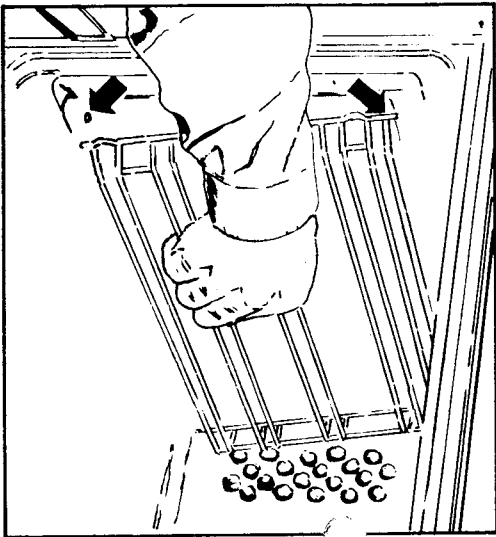

Make sure the electricity supply is switched ON.

Your Built-Under Oven is fitted with an Electronic Clock and Timer. When switching the oven on for the first time or if the power supply has been interrupted the Electronic Clock Display will flash **EE.EE.EE**. To set the clock to the time of day press both the Minute Minder **Ⓢ** and Duration **▶** Buttons and hold them in while turning the Time Control **↻** until the time of day appears in the Display. When you have reached the right time release the buttons and the clock will operate. Remember that the clock is a twenty-four hour one so that 3 o'clock in the afternoon will show in the display as **15.EE**.

Manual/Automatic

For normal operation (without automatic timing) the Manual/Automatic Switch must be turned to **Ⓜ** (Manual).

To remove the 'new smell', heat up the empty oven for 30 minutes keeping the door closed. To do this turn the Oven Function Selector to **Ⓜ** – the Mains ON/OFF light on the Control Panel and the light inside the oven will come on – and set the Oven Thermostat to 250. When you do this the Oven Thermostat Light on the Control Panel will come on.

If the flame on the burner appears to be irregular check that the top has been properly located i.e., the marking on the top is in line with the igniter (see opposite). If the burner fails to ignite properly check that the igniter is clean (see page 21). The gas should be turned off and the burners allowed to cool before any adjustments or cleaning are done.

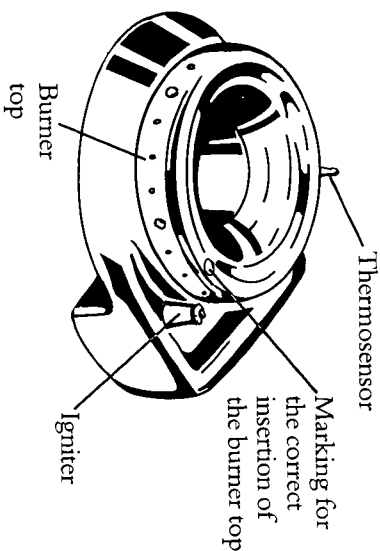

Flame Failure Device

Each burner is fitted with a flame failure device. Should the flame be accidentally blown out the gas supply to the burner will automatically be cut off within 30 seconds.

Cooking

Your gas hob is fitted with three medium and one large extra powerful burner which is positioned at the front right hand side.

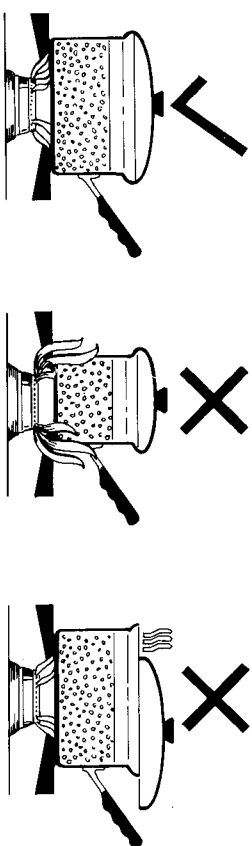

Bring items to the boil on the large flame setting then turn to the small flame setting for simmering. For maximum efficiency the flame should always remain underneath the pan and in order to save time and energy always try to cook in a pan with a lid on. Do not use an asbestos mat or anything else under the pan to spread the heat as this will cause damage to the burners.

Cooking on the Ceramic Hobs

When placing a pan on the ceramic surface make sure that the base is clean, free from grit, and dry.

A pan may be moved away from the cooking zone to reduce the heat quickly and be left only partly over the cooking zone provided that the control is turned down from the maximum setting.

Never leave a cooking zone on for long periods when not covered by a pan. Spillage should be dealt with as soon as it occurs. Any spillage left on the surface after cooking should be cleaned off (see page 21) before the hob is switched on again to prevent baking on.

Do not cook directly on the hob itself and under no circumstances should the hob be used with aluminium foil in contact with the hob surface. Whilst the hob may be used as an additional work surface care must be taken to ensure that it is not scratched (i.e. do not use the hob as a chopping board).

Do not put plastic items on a warm cooking zone.

IMPORTANT — DO NOT USE THE HOB IF IT IS CRACKED – SWITCH

OFF AT THE MAINS IMMEDIATELY and contact your nearest Hotpoint Service Office, for telephone number see back of handbook.

Hob Covers

A set of four attractive brown hob covers to go over each of the hotplates is available as an optional extra (Part No. 630073). This is available from any Hotpoint Service Centre (see page 23).

Gas Hobs Models 64730 and 64736

The Controls

The Gas Hob is operated by the controls on the Control Panel of the Built Under Oven Model 61350. The control for each burner is clearly indicated on the Control Panel and can be regulated to any cooking rate from a very fast boil down to a simmer.

Ignition

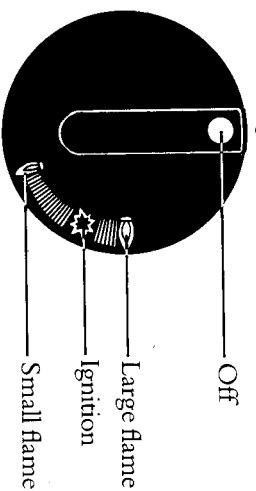

To light the gas press and turn the control for the required burner to the ignition position **M**. Keep the control pushed in for about 5

seconds. If the burner does not ignite or goes out repeat this process. The size of the flame can then be regulated.

The controls

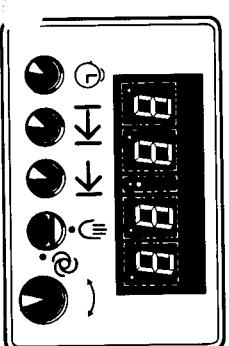

Variable Grill Control Function Selector Oven Thermostat

Oven Thermostat Light (red)

Mains ON/OFF Light (yellow)

Mains ON/OFF Light (Yellow)

This light will come on and stay on as soon as the Function Selector is turned on.

Before using the Oven the Function Selector must be turned to the appropriate position. The control has three settings:



Conventional



Fan-assisted



Fan-assisted grilling

Now turn the Oven Thermostat clockwise to the required temperature. The thermostat light will immediately come on when either Conventional or Fan-assisted is selected and will remain on until the oven reaches the required temperature. The light will then automatically go on and off during cooking as the oven thermostat maintains the temperature. If the thermostat light does not come on when the thermostat is turned on, make sure that the Manual/Automatic Switch is turned to (Manual). When Fan-assisted grilling is selected the thermostat light will not operate.

To use the grill set the Thermostat Control to and the Variable Grill Control within the range 1-9 and remember to keep the oven door closed.

After use, always set the controls back to 'O' (Off).

Note: The Oven Thermostat must be turned anti-clockwise to switch off.

The Automatic Oven Timer

The Oven can be controlled by the Automatic Timer.

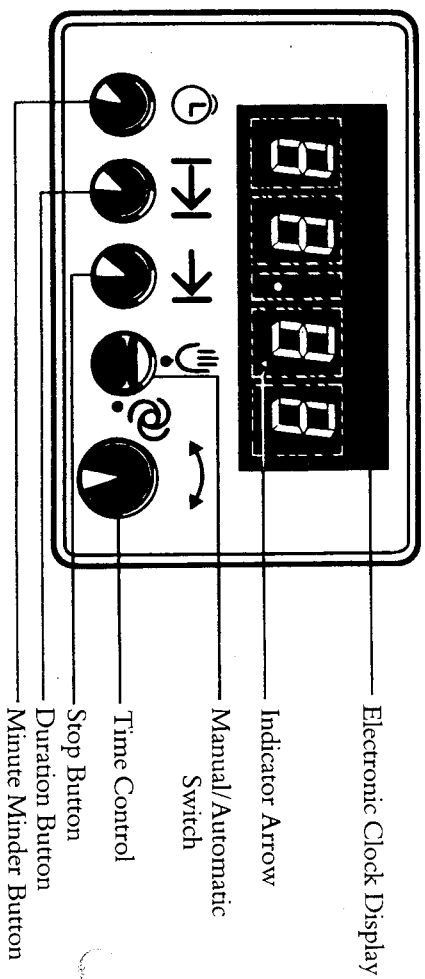

The Timer is controlled by the Electronic Clock. Check that the clock is showing the correct time, if not reset it by pressing in both the Minute Minder and Duration Buttons and hold them in while turning the Time Control until the correct time appears in the Display.

The Ceramic Hob Model 63660











The Minute Minder

The Minute Minder can be used independently or in conjunction with the automatic timer and will give an audible reminder. It does not control the operation of the ovens.

Press the Minute Minder Button  and  will appear in the Display. Holding the button in turn the Time Control  to the length of time required. Release the button and the Display will revert back to the time of day but with the arrow still showing above the Minute Minder Button. The Minute Minder Button can be pressed at any time to show how long it will be before it sounds. At the end of the set time the Minute Minder will sound for approximately 2 minutes but can be switched off beforehand by pressing any one of the buttons.

To set the timer to switch ON and OFF automatically

1. Turn the Manual/Automatic Switch to . An indicator arrow  in the Display immediately above will start to flash.
2. Press the Stop Button . An indicator arrow will appear above the button and the Display will show . Holding the Stop Button in turn the Time Control  until the time you want the meal to finish cooking appears in the Display. Release the button and the clock will revert back to the time of day but with the two indicator arrows still showing.
3. Press the Duration Button , an indicator arrow will appear above the button and the Display will show . Holding the Duration Button in turn the Time Control  until the length of time you want the meal to cook for is shown in the Display. (This sets the switching-on time.) Release the buttons and the clock will revert back to the time of day with the three indicator arrows still showing.
4. Turn the Oven Thermostat to the required temperature and the Function Selector to

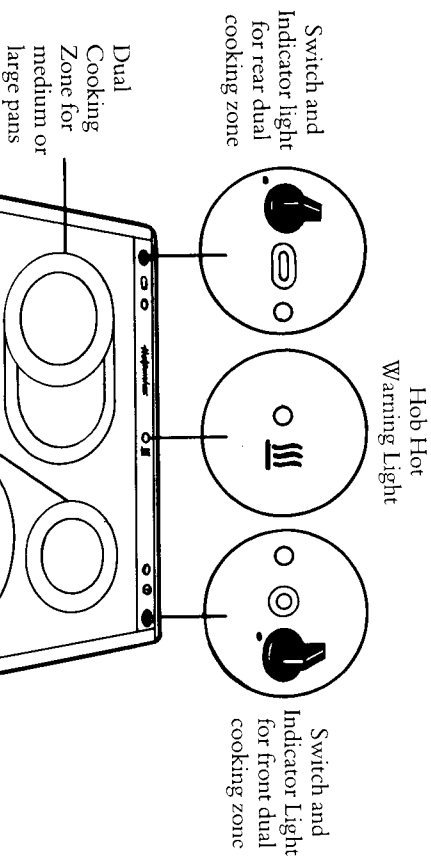

The cooking surface is a heat resisting, extra tough glass-ceramic with a smooth surface which is unaffected by intense heat or rapid cooling. The areas not heated remain relatively cool.

The glass ceramic surface has four cooking zones. Soon after you turn one of the controls the Hob Hot Warning Light in the centre of the back Control Panel comes on and will stay on as long as any of the cooking zones are above 40°C thus indicating that one or more of the zones are hot.

Dual Cooking Zones

Two of the cooking zones are fitted with dual circuits so that a wide variety of different size saucepans can be used.

When you turn the rear left hand hob control on, the round area of the cooking zone will heat up. If you turn the left hand switch at the back of the hob to the white mark, the indicator light will come on, and the whole of the extended cooking zone will heat up, ideal for the larger size pan or fry pan.

When you turn the front right hob control on, the inner part of the cooking zone will heat up ideal for small milk pans. If you turn the right hand switch at the back of the hob to the white mark, the indicator light will come on and the whole of the large cooking zone will heat up.

The Hobs (cont'd)

The Front Automatic Fast Heat Plates on the Electric Hobs

Turn the control to the required setting, the hotplate will quickly heat up the saucepan and its contents before cutting back to the required level of heat. There is no need to first select a high setting and then turn the power down, this will reduce the necessity for having to watch the pan and help prevent boiling over.

Suggested settings are as follows:

- 1 – 3 Simmering
- 2 – 3 Cooking of small quantities
- 4 – 7 Cooking/Boiling
- 5 – 9 Frying.

Higher settings than the above may be necessary if:

- there is a large amount of food to be cooked
- you are cooking in an open pan
- you are cooking in a pan with an uneven base (not recommended)
- you are cooking in a pan larger than the hotplate

Using the correct pan

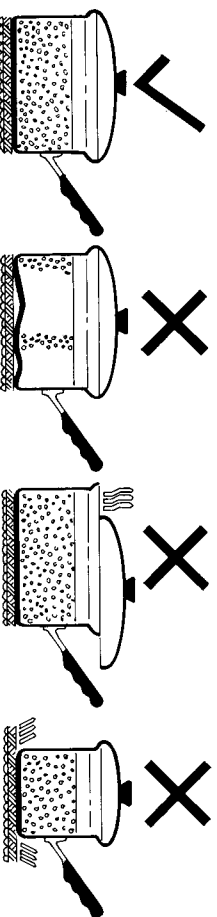

Saucepans should preferably be heavyweight (suitable for electricity) and should be completely flat (machined base).

An uneven pan base will result in longer cooking times and cost you more in electricity. Pans with a damaged or rough base should not be used on ceramic hobs as they could scratch the glass surface. Pans with a recessed or ridged base should not be used. Do not use an asbestos mat or anything else under the pan.

Cooking with the saucepan lid on will also save you time and electricity.

Always select a pan which is the same size as the hotplate or cooking zones – small pans, ideally, should not be used on the large hot plates or cooking zones.

Salt or water on the underside of the pan could damage the plates so always keep them dry and clean.



5. The oven will automatically switch ON (the middle indicator arrow will disappear) when the pre-selected start time has been reached and switch OFF when the Stop time is reached. At that time the arrow above the Stop button will disappear and the Minute Minder will start to sound to remind you that the meal is ready to take out. The Minute Minder will sound for approximately 2 minutes but can be switched off beforehand by pressing any one of the buttons.
6. After use turn the appropriate controls to 'O' (Off) and turn the Manual/Automatic switch to  (Manual). The arrow above the switch will cease to flash.

To set the Timer to switch OFF only





The timer may be used to switch the oven off.

1. Follow Steps 1 and 2 as above.
2. Turn the Oven Thermostat to the required temperature and the Function Selector to the type of heating required (see Page 7). The Oven Thermostat light will come on and the oven start to heat up.
3. The oven will automatically switch OFF when the stop time is reached. At that time the arrow above the Stop Button will disappear and the Minute Minder will start to sound to remind you that the meal is ready to take out. The Minute Minder will sound for approximately 2 minutes but can be switched off beforehand by pressing any one of the buttons.
4. After use turn the appropriate controls to 'O' (Off) and turn the Manual/Automatic Switch to  (Manual). The arrow above the switch will cease to flash.

To cancel the Timer and return to MANUAL operation

If you wish to use the oven manually after a timed operation has been set press the Stop Button  and holding it in turn the Time Control back to . Release the button and the clock will revert back to the time of day. Turn the Manual/Automatic Switch back to  (Manual). The arrow above the switch will cease to flash.

General notes on using the Automatic Timer

1. When setting any part of the timer always keep the appropriate button pressed in with one hand and turn the Time Control at the same time with the other hand.
2. After a button has been released an arrow will remain above it in the Display to act as a reminder of what has been selected.
3. If the arrow above the Manual/Automatic switch flashes, this indicates that one of the buttons needs to be set.
4. If you wish to cancel or change one of the settings simply press the appropriate button and turn the Time Control back to . Reset the appropriate button as required.
5. If after setting the timer or when the meal has started to cook you want to know how long it will take simply press the Duration Button  and the length of time will be shown in the Display.
6. If you want to know when the cooking will come to an end simply press the Stop Button  and the finishing time will be shown in the Display.
7. The Minute Minder can be set to come on before the end of automatic cooking, e.g. to remind you to put the vegetables on. The Minute Minder will sound a second time at the end of the automatic cooking period.
8. Always remember to switch the Manual/Automatic Switch back to  (Manual) after you have used the Automatic Timer.

Cooking in the Oven

The temperatures given in the baking and roasting charts on the following pages are intended as a guide. You may find that you need to vary these to suit your personal taste.

IMPORTANT – Whichever method of cooking you are using you should **never** cook directly on the floor of the oven. If using aluminium foil, **never** allow it to touch the sides of the oven. **Never** cover the oven interior or shelves with foil.

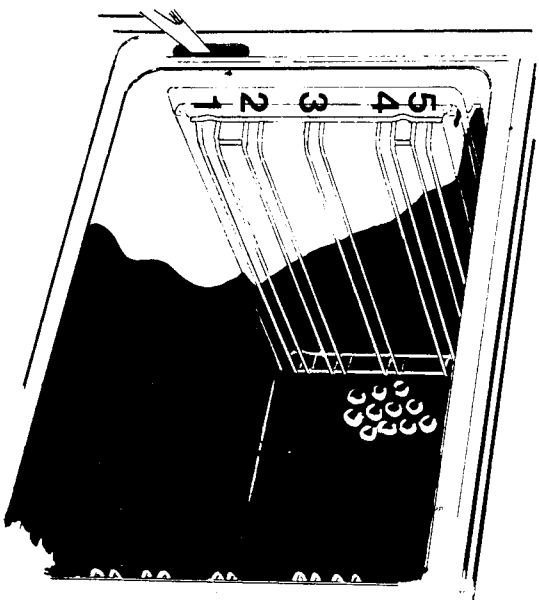



Always use the door handle to open the oven and not the vapour guard as this becomes very hot during cooking and will remain so for some time after the cooking has ended.

To obtain the best results it is recommended that you use the baking tray and meat pan provided either on their own if you are cooking on one shelf only or if cooking on more than one shelf in conjunction with your own baking tins.

Only put in the shelves or fittings you actually want to use. Unused shelves only restrict access and get in the way. If possible it is a good idea to remove the fittings when you have finished cooking so that when you next come to use the oven you do not inadvertently heat up unnecessary shelves or tins – as well as being more convenient this will even save electricity.

Baking and Roasting using Conventional Heating

Turn the Function Selector  to  and the Oven Thermostat  to the required temperature.

The Hobs

Ceramic Hob Model 63660 and Electric Hobs Models 63510 and 63516

The Controls

The Ceramic and Electric Hobs can be operated either by the controls on the control panel of the Built Under Oven (model 61330) or by the separate **Control Panel (Model 63210)**

The relevant control for each ring is clearly indicated on the control panel and has nine settings. Simply turn the control to the setting required and the hob ON/OFF light will come on. When switching off turn the control to the 'O' (Off) position.

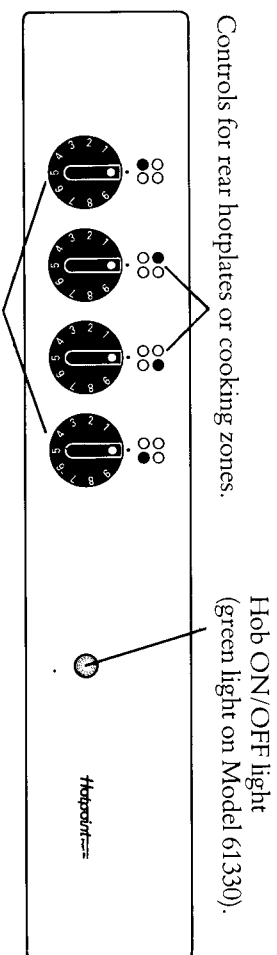

Controls for Front Hot Plates or Cooking Zones.

The Rear Hotplates on the Electric Hobs and all the Cooking Zones on the Ceramic Hob

To bring items to the boil turn the control to setting 9 initially and then turn down to a lower setting as required. Similarly when frying turn to setting 9 until the fat is hot and then lower the setting according to your requirements.

Note: Never leave hot fat or cooking oil unattended.

Suggested settings are as follows:

- 1 – 3 Simmering
- 2 – 3 Cooking of small quantities
- 4 – 7 Cooking/Boiling
- 5 – 9 Frying.

Cooking in the Oven

(cont'd)

Warming Dishes

The oven can be used just to warm dishes or for keeping food hot. Dishes should not be placed directly on the floor of the oven and the Oven Thermostat should not be set above 75°C.

Take care, particularly with delicate crockery.

Temperature Conversion Scale

The Oven Thermostat is marked in degrees Centigrade. This chart will help when recipes show the alternative Fahrenheit scale or such terms as 'Slow Oven', 'Moderate Oven' and 'Hot Oven' are used.

Oven Temperature Guide	Centigrade Scale	Fahrenheit Scale
Cool	70°C	150°F
	80°C	175°F
	100°C	200°F
	110°C	225°F
	120°C	250°F
Slow	140°C	275°F
	150°C	300°F
	160°C	325°F
Moderate	180°C	350°F
	190°C	375°F
Fairly Hot	200°C	400°F
	220°C	425°F
Hot	230°C	450°F
	240°C	475°F
Very Hot	250°C	500°F
	260°C	525°F

Baking

Always put the item you are baking in the centre of the shelf. You will find that shelf position 1 or 2 will give the best results. If you are baking on more than one shelf or cooking cakes in tinware, then the fan assisted system is recommended.

Baking Chart

Food	Temperature °C	Shelf Position
Bread	200-220	1-2
Scones	200-220	1-2
Soufflé	190-210	1-2
Apple tart	180-200	1-2
Swiss roll	180-190	1-2
Victoria sandwich	170-180	1-2
Rich fruit cake	130-140	1
Merengues	75	1-2

Roasting

If roasting in an open dish, shelf position 2 is recommended.

If roasting directly in the meat pan use the anti-splash tray supplied so that, during cooking, all the fat drains into the cavity base, this ensures that oven cleaning is kept to a minimum.

If roasting or casserole cooking in a closed dish, it should be placed on one of the shelves either at position 1 or 2 depending on the size of the dish.

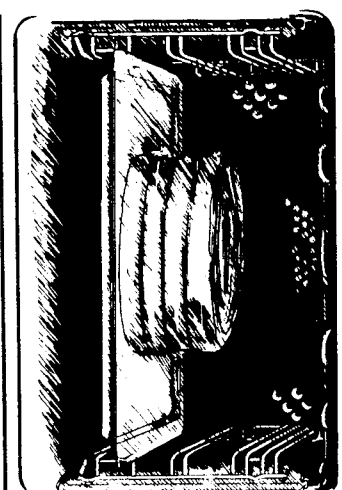



Roasting Chart

Food	Temperature °C	Shelf Position
Poultry	200	2
Beef	180-190	2
Game	180-200	2
Lamb	170-190	2
Baked fish	170-190	2
Veal, Pork	170-180	2
Casserole	150-180	1-2

Cooking in the Oven (cont'd)

Baking and defrosting food using fan assisted heat

Turn the Function Selector  to  and the Oven Thermostat to the required temperature.

Baking

The advantage of this method of cooking is that as the oven heats up more quickly and generally foods cook at a lower temperature than in a conventional oven, pre-heating the oven is only required if the cooking time is less than 25 minutes.

Since the distribution of heat is more even most foods will cook satisfactorily in any shelf position, but the shelves should be evenly spaced. If only one shelf is being used then position 1 is preferable. Temperatures selected should be 10-40°C lower than with conventional heating – see separate cookery book.

When cooking a complete meal

– for instance roast beef, roast potatoes, Yorkshire pudding and apple pie, place meat/potatoes on anti-splash tray in meat pan in position 2 with apple pie and Yorkshire pudding in position 3.

When all three shelves are used to cook large quantities of food for home freezing or parties, it may be necessary to increase the cooking times by a few minutes to allow for the larger mass of food and take out food on the upper shelf slightly earlier. If you are batch cooking you will need to pre-heat the oven. Use the baking tray supplied with the oven in position 1 and your own baking tins at position 3 if baking on two shelves. If batch baking on three shelves use positions 1, 3 and 4.



Defrosting

Without Heat – for frozen foods such as cakes, fruit, etc. the Oven Thermostat should be set at 'O' (Off) and shelf position 2 used.

With Heat – for chicken portions, sausages, meat rolls, etc. turn the Oven Thermostat to 50-75°C and again use shelf position 2. This method of defrosting is only recommended for food up to 2kg in weight and the food should be cooked immediately afterwards.

Fan Assisted Grilling – Roasting

In this method of cooking the top heating element and the hot air fan are switched on and off alternately. It is ideal for roasting a joint or chicken and has the same results as if you were cooking on a rotisserie but more economically as the door is left closed.

There is no need to pre-heat the oven. Insert the meat tin and anti-splash tray at shelf position 1.

Put the food on one of the wire shelves at shelf position 2 or 3 depending on the height of the food. Turn the Function Selector to  and the Oven Thermostat to the required temperature. For large pieces of meat or several pieces a lower temperature and a longer grilling time will be necessary.



Roasting Chart

Food	Temperature °C
Poultry	180-200 (turn over approx. half way through cooking period)
Duck	200
Lamb	160-180
Pork	150-180

Grilling

The oven can be used as an ordinary grill for such items as sausages, flat pieces of meat and fish. Turn the Oven Thermostat to  and the Variable Grill Control to the required setting 1-9.

Grilling should always be done with the oven door **CLOSED**. There is no need to pre-heat. Use the grill pan with the anti-splash tray and the reversible grill pan grid if necessary in position 2-4 according to the thickness of the food. If you find excessive smoke being emitted, turn the Variable Grill Control to a lower setting and/or move the shelf with the food on to a lower position.



Key Contacts

After Sales Service

Over 1100 trained specialists, directly employed by us, ensure that you have complete confidence in both the appliances and services we offer.

Repair Service

UK: 08709 066 066

(Open 8 to 8 Mon - Fri, 8 to 6 Sat & 10 to 4 Sun)

www.theservicecentre.co.uk

Republic of Ireland: 1850 302 200

Note: Our Service Operators will require the following information:

Model Number

Serial Number

Extended Warranties

UK: 08709 088 088

(Open 8 to 6 Mon - Fri)

www.theservicecentre.co.uk

Republic of Ireland: 1850 502 200

Genuine Parts and Accessories

UK: 08709 077 077

(Open 8-30 to 5-30 Mon - Fri, 8-30 to 12 Sat)

www.theservicecentre.co.uk

Republic of Ireland: (01) 842 6836

General Domestic Appliances Limited, Morley Way, Peterborough, PE2 9JB